

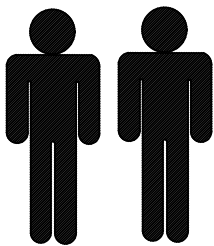

- PL -Montaż powinnien być przeprowadzony zgodnie z instrukcją montażu producenta, w przeciwnym razie może pojawić się niebezpieczeństwo użytkowania.
- DE- Die Installation sollte gemäß den Installationsanweisungen des Herstellers erfolgen, da sonst die Gefahr einer Verwendung besteht.
- EN- Installation should be carried out in accordance with the manufacturer's installation instructions, otherwise there may be danger of use.
- CZ- Instalace by měla být provedena v souladu s instalačními pokyny výrobce, jinak může dojít k nebezpečí použití.
- SK- Inštalácia by sa mala vykonávať v súlade s inštaláčnymi pokynmi výrobcu, inak môže existovať nebezpečenstvo použitia.
- RU- Установка должна выполняться в соответствии с инструкциями производителя по установке, в противном случае может возникнуть опасность использования.
- SRB- Instalaciju treba izvesti u skladu sa uputstvima za ugradnju proizvođača, jer u suprotnom može doći do opasnosti od uporabe.
- HR- Instalaciju treba izvoditi u skladu s uputama za ugradnju proizvođača, jer u suprotnom može doći do opasnosti od uporabe.
- HU- A telepítést a gyártó telepítési útmutatója szerint kell elvégezni, különben a használat veszélye áll fenn.



60 min

Company: DIG-NET sp. z o. o. sp. k.
Mroczeń 65a, 63-611 Mroczeń
e-mail: info@dignet.eu
NIP:6191953919

Potrzebne narzędzia/ Benötigtes Werkzeug/ Required tools/ Potřebné nástroje/
Potrebné nástroje/ Необходимые инструменты/ Potreban alat/ Szereléshez szükséges szerszámok

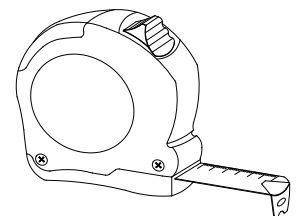
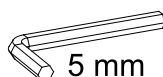
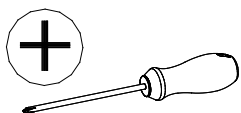

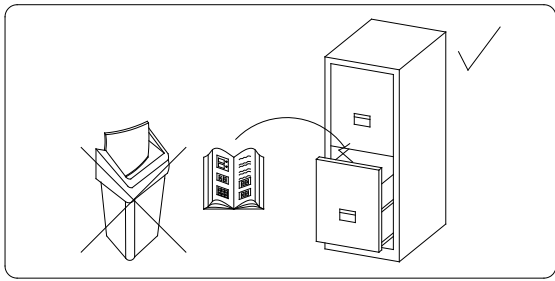

ZAG140	1360,0	730,0	100,0	1	1/1
--------	--------	-------	-------	---	-----

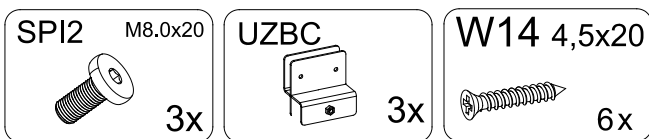
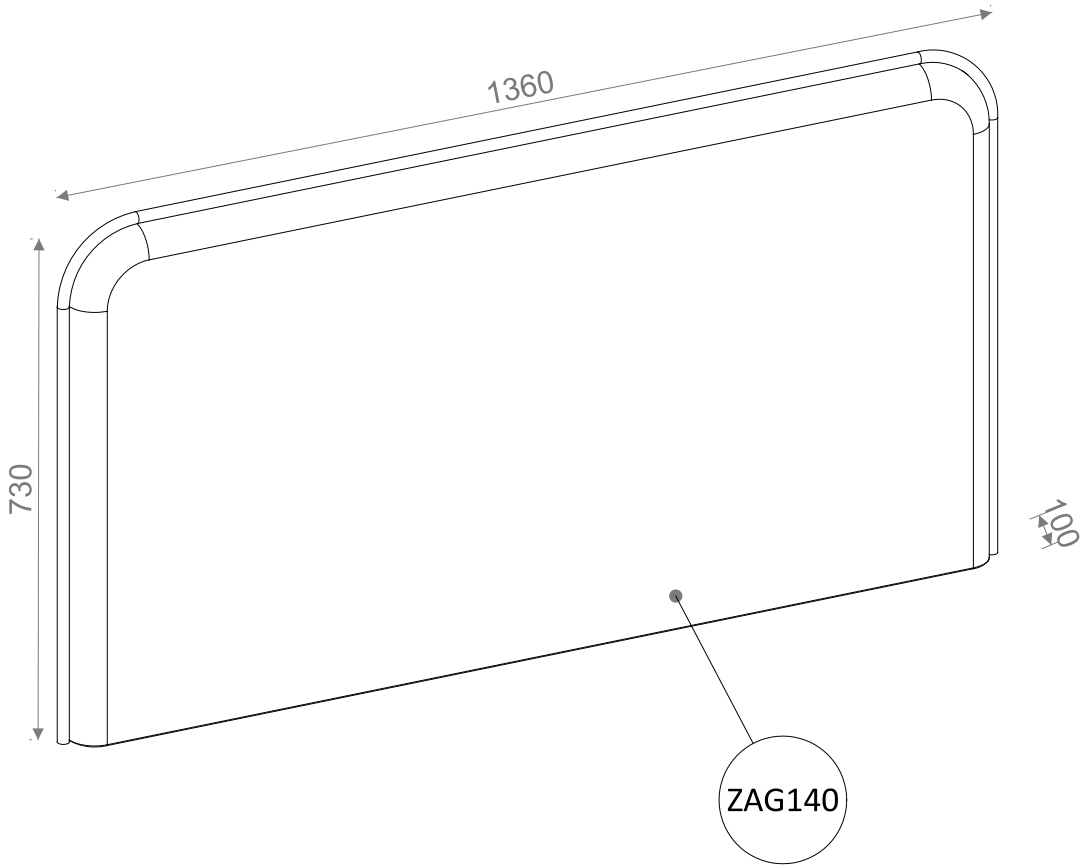
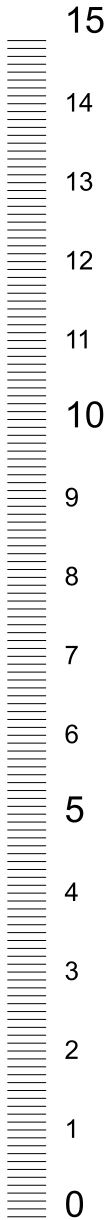

Proszę sprawdzić kompletność okuć przed montażem
 Bitte überprüfen Sie die Vollständigkeit der Fittings vor der Montage
 Please check the completeness of the fittings before assembly
 Пожалуйста, проверьте комплектность фурнитуры перед установкой

Prosím zkontrolujte úplnost konektorů před instalací
 Prosím skontrolujte úplnosť konektorov pred inštaláciou
 Prije montaže provjerite cjelovitost okova
 Pre postavljanja proverite kompletnost okova
 Kérjük, ellenőrizze a szerelvények teljességét a szerelés előtt

1

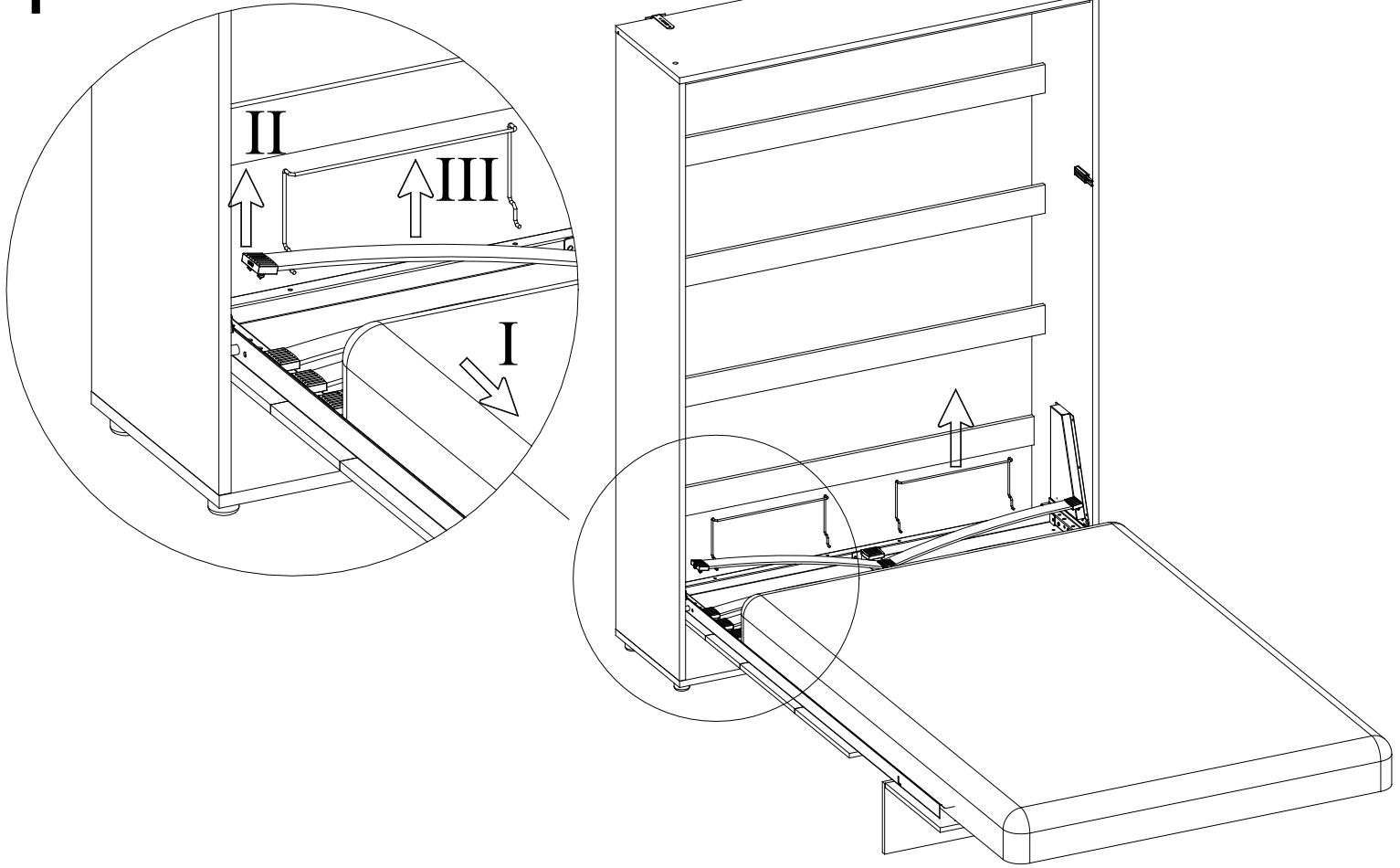

2

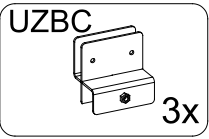

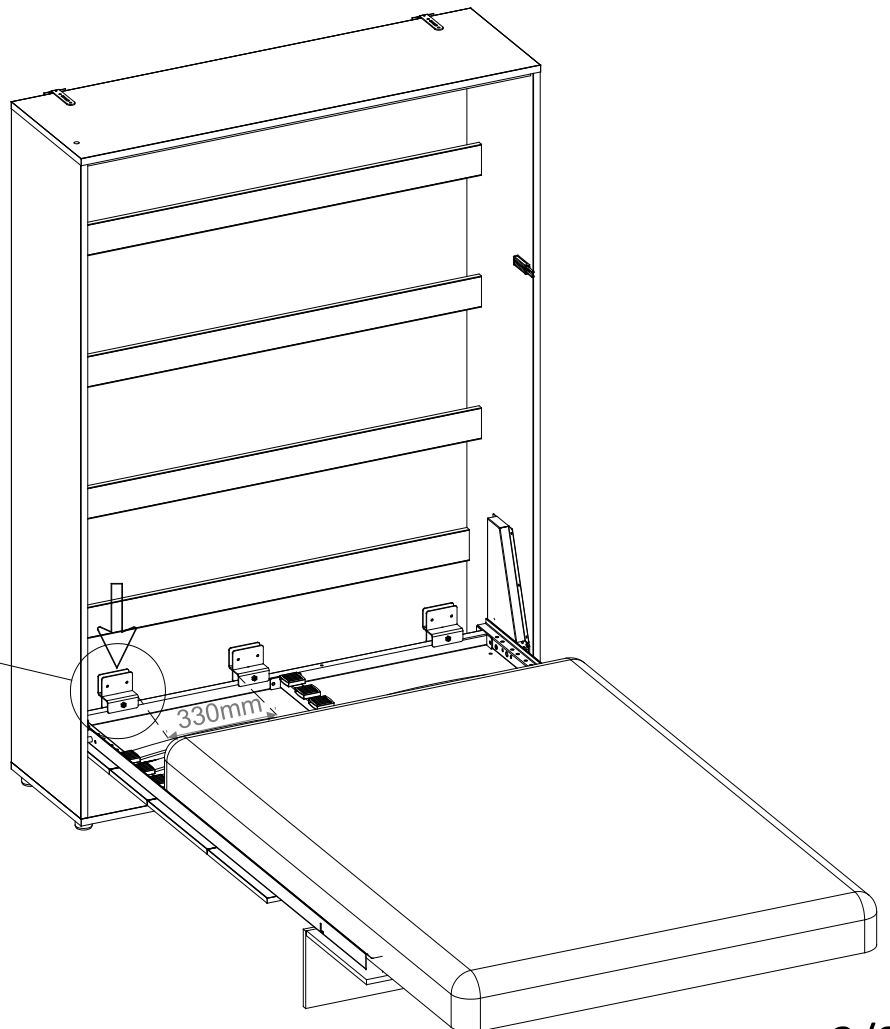
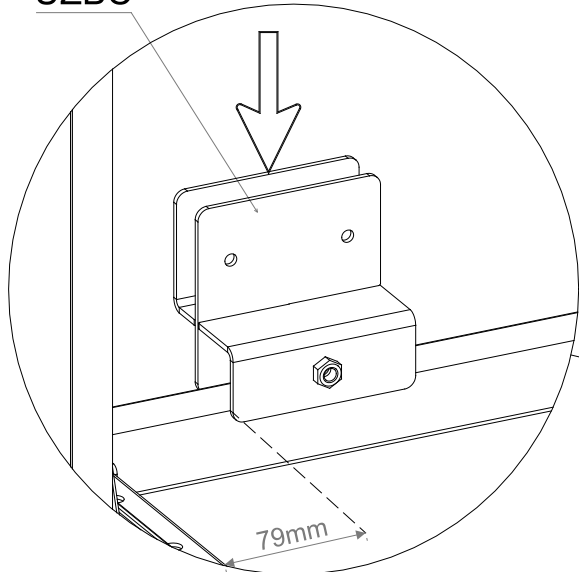

UZBC

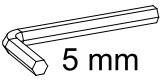

3

SPI2 M8.0x20
3x



5 mm

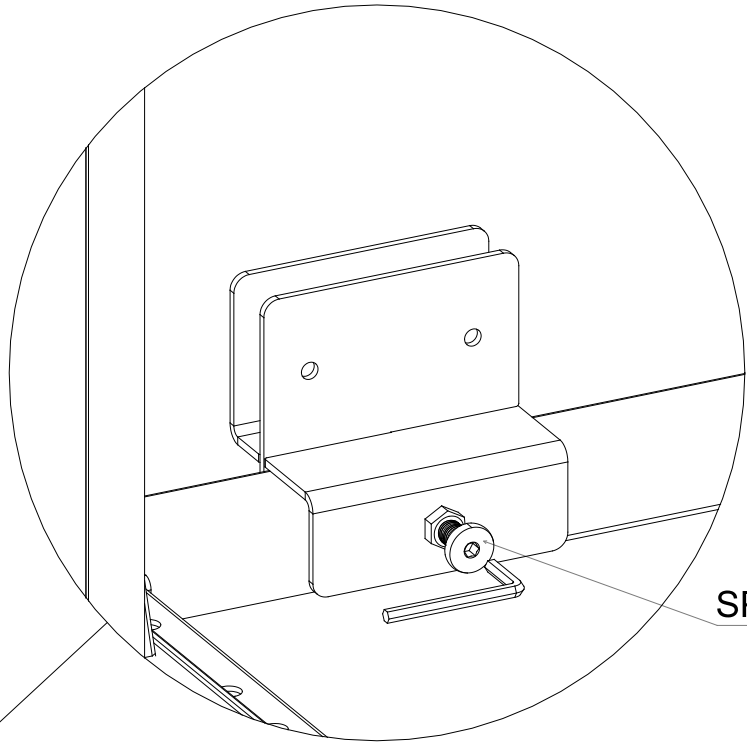

SPI2

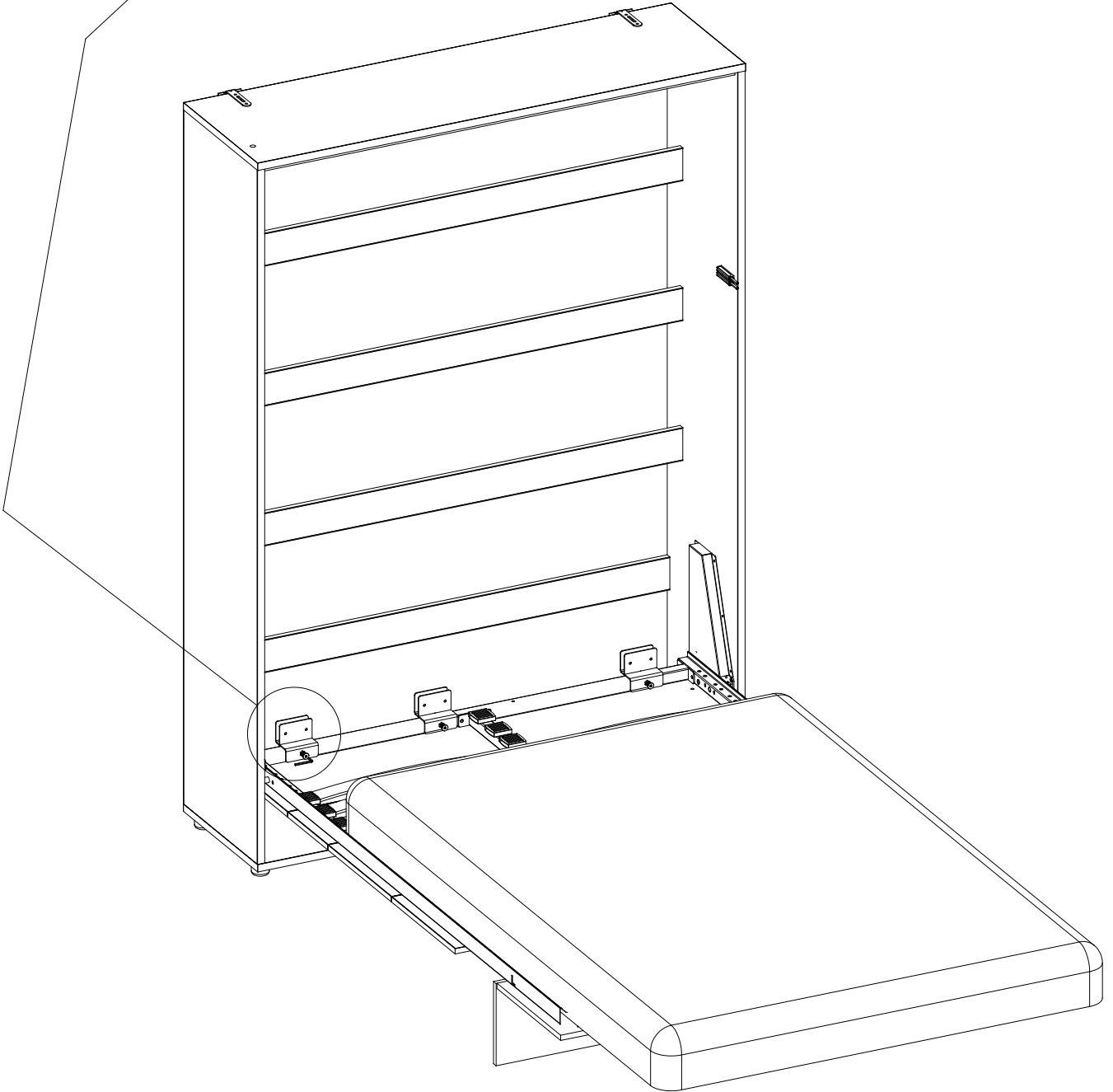

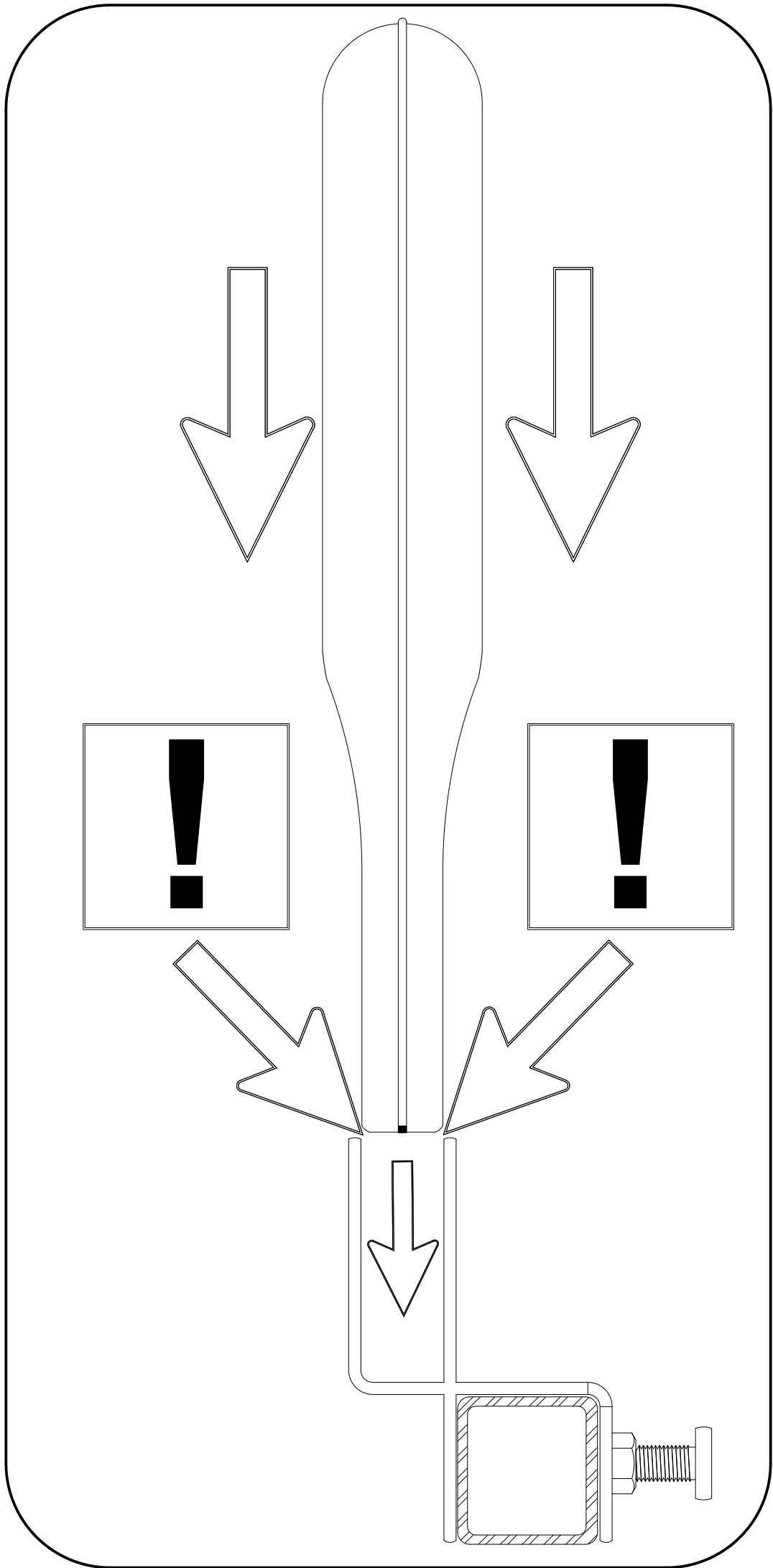

4

A=B

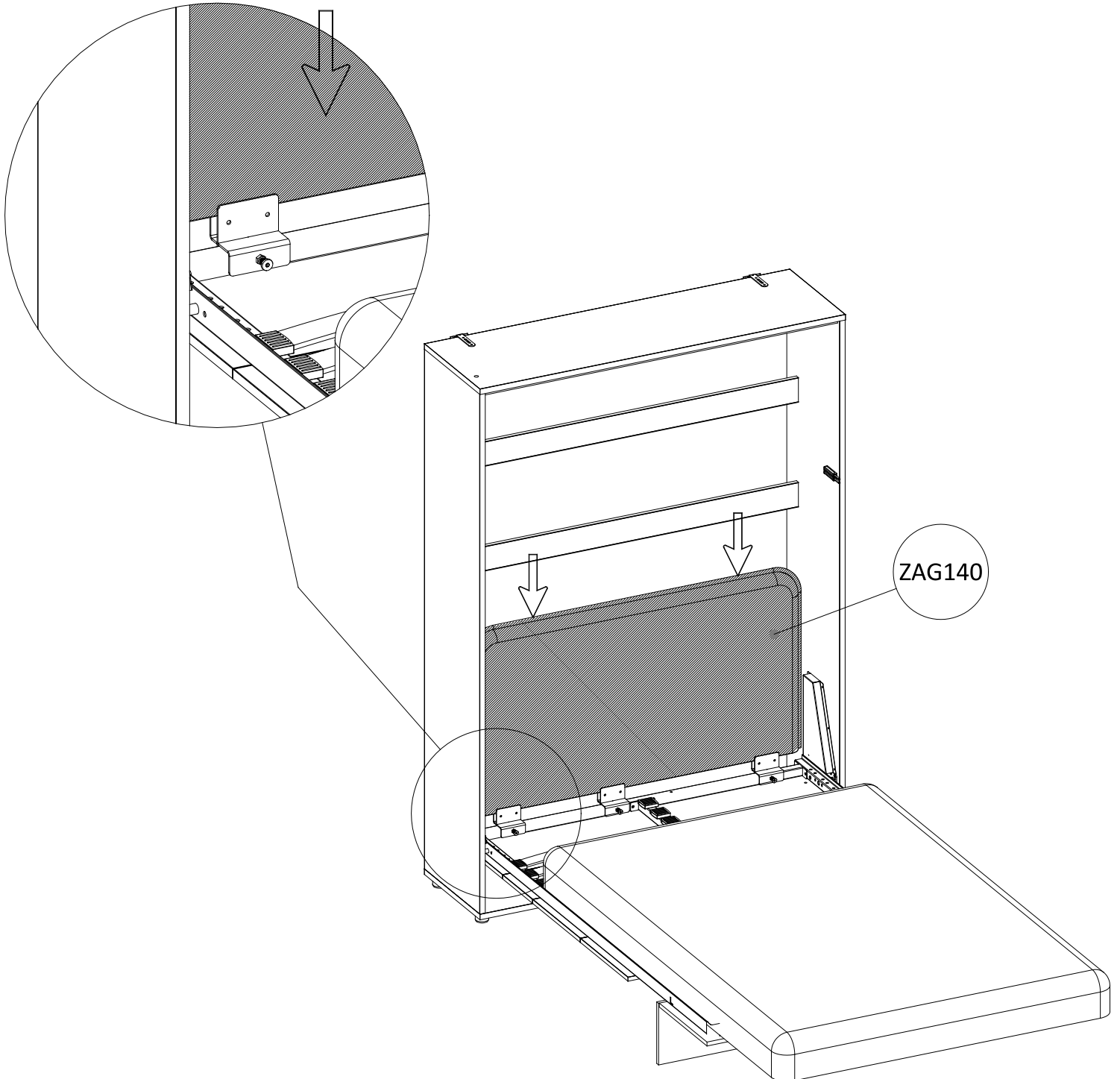
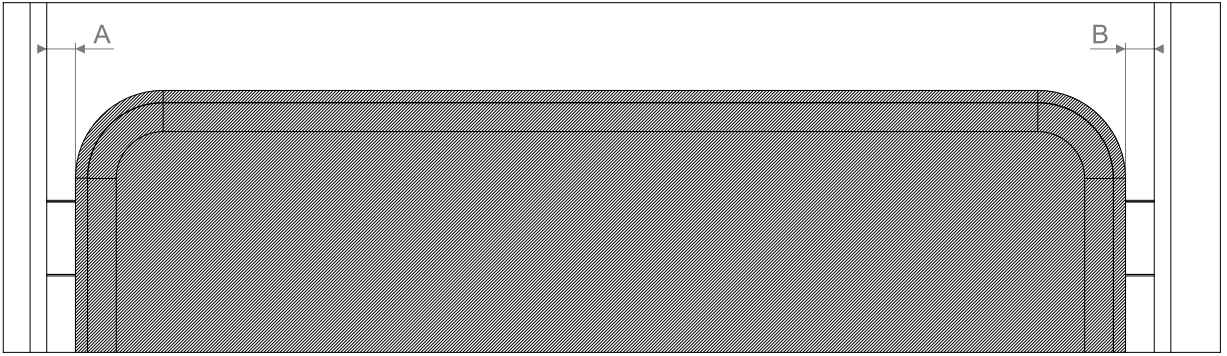

5

W14 4,5x20



6x

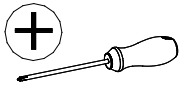

W14

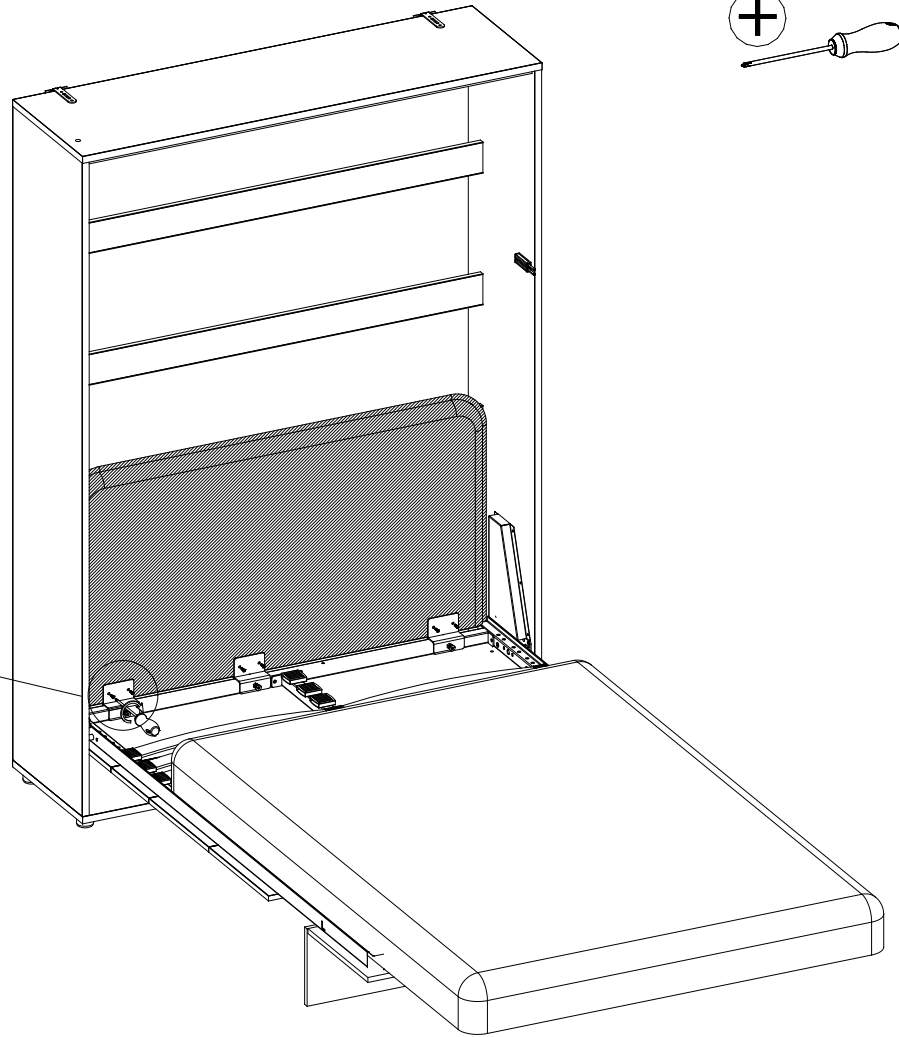
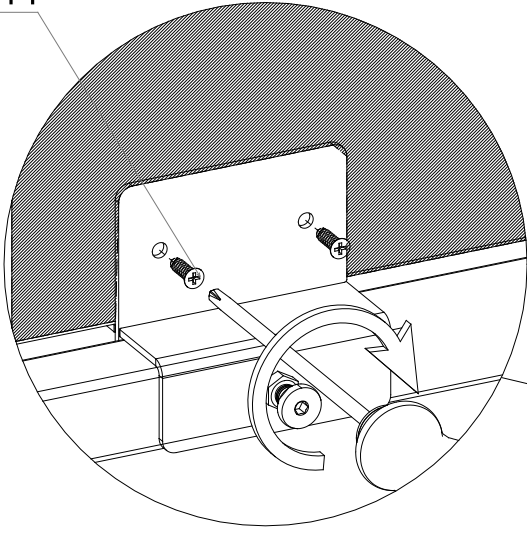

6

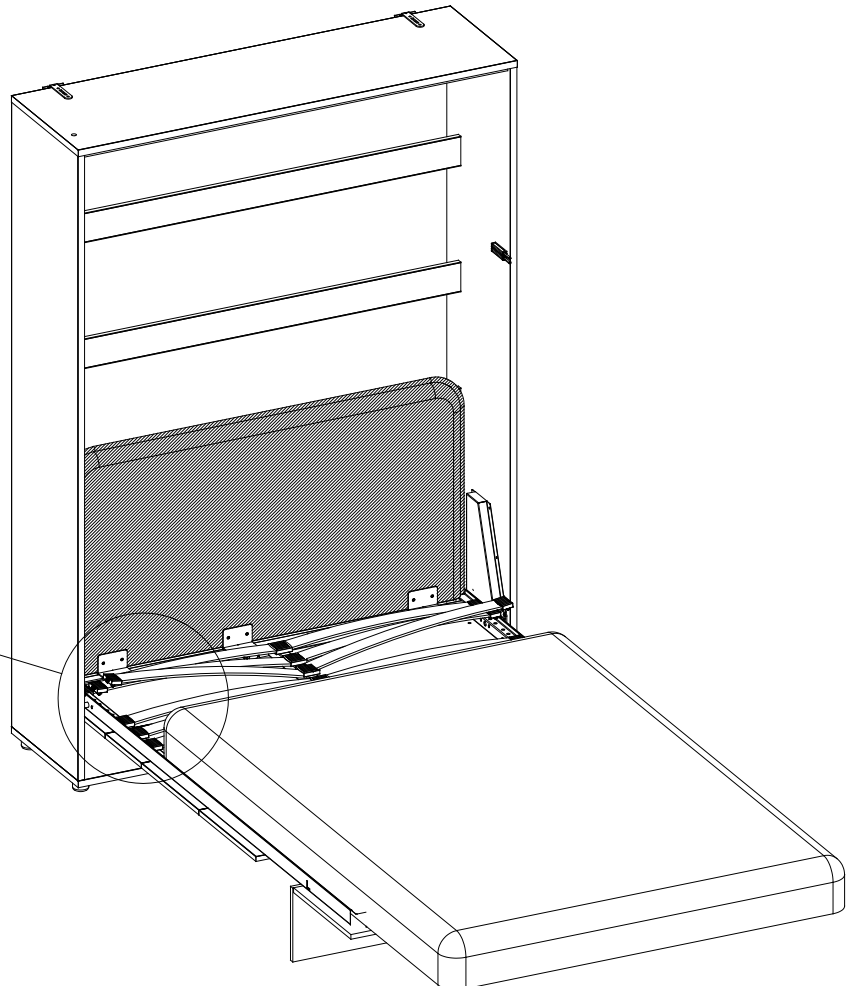
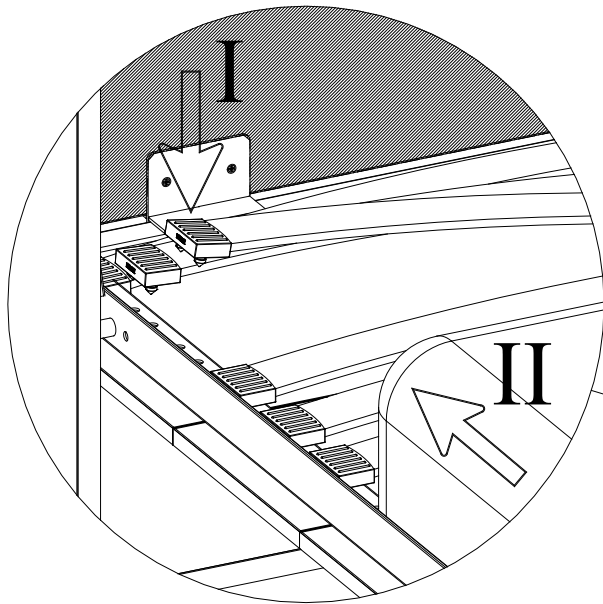

7

