

Model: SONATIA RTV 150 3D
Modell: SONATIA RTV 150 3D1SZ
Modell: SONATIA RTV 150 3D2SZ

Strona: 1/10
Blatt Nr: 1/10

BOGART.

Do montażu potrzebne są:
Für die Montage dieser Type benötigen Sie:
For assembly you need:
Pour le montage, vous avez besoin de :

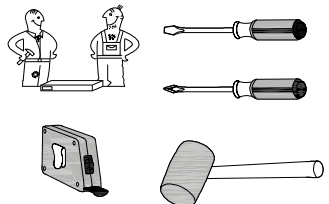

- PL INSTRUKCJA MONTAŻOWA
- D MONTAGENLEITUNG
- GB ASSEMBLY INSTRUCTIONS
- SK NÁVOD NA MONTÁŽ
- CZ MONTÁŽNÍ NÁVOD
- IT ISTRUZIONI DI ASSEMBLAGGIO
- FR NOTICE DE MONTAGE

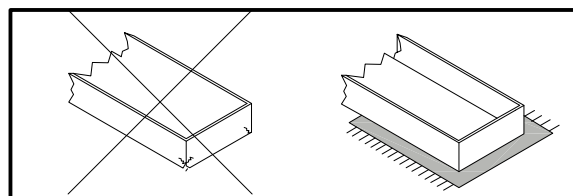
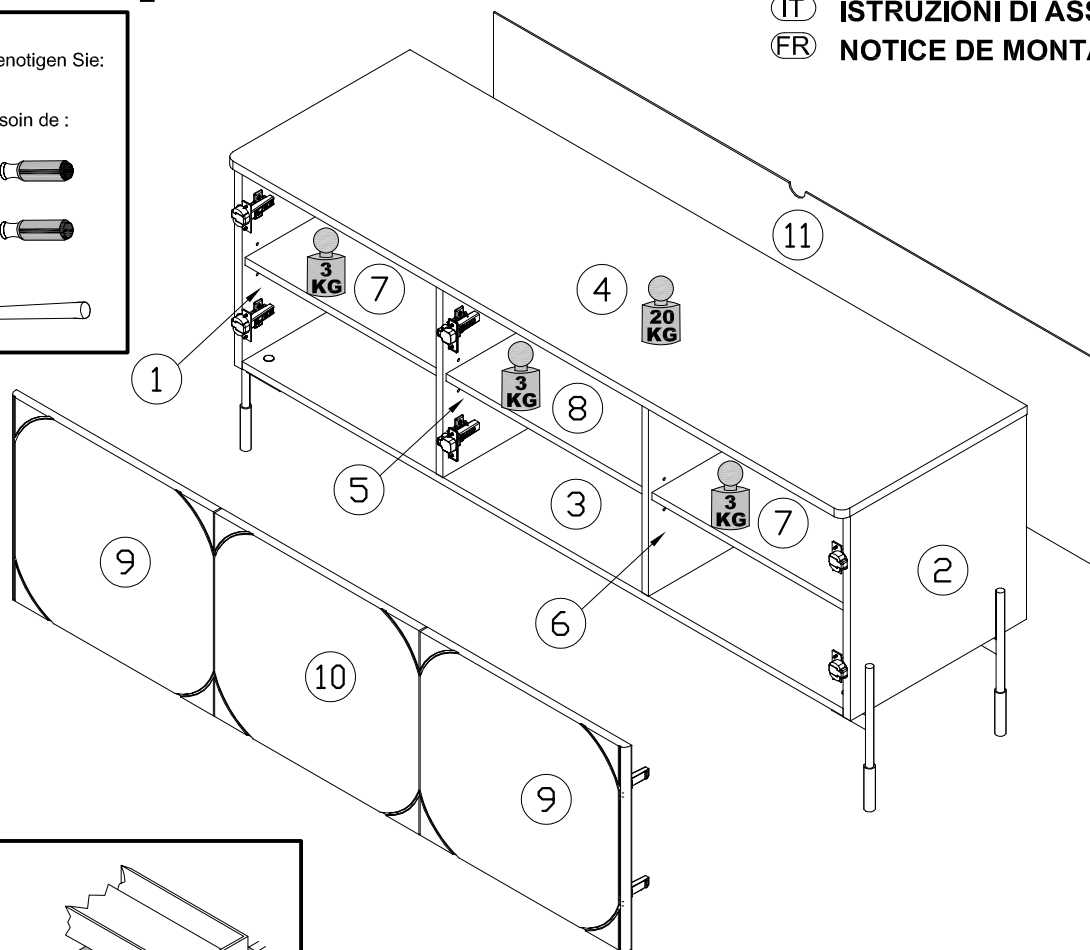
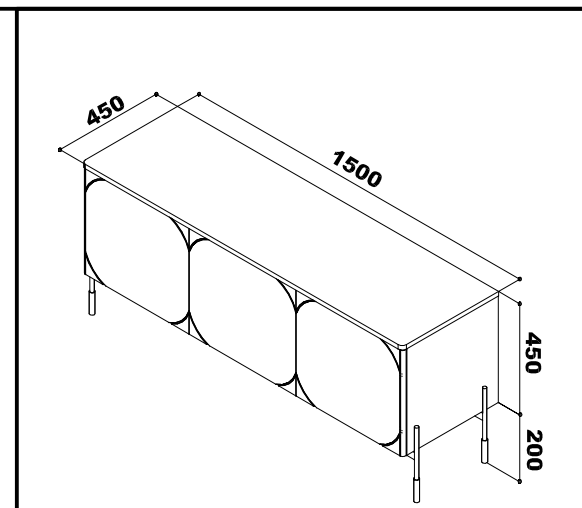

PL Szanowny Kliencie. Gdyby brakowało jakiejś części lub była by uszkodzona, to proszę oznaczyć część krzyżykiem na instrukcji montażowej i przesłać instrukcję razem z reklamacją.

D Sehr geehrter Kunde. Sollte ein Teil fehlen oder beschädigt sein, kreuzen Sie bitte dieses deutlich auf der Montageanleitung an und schicken Sie zu uns ab.

GB Dear customer. Should there be any place missing or damaged, kindly mark this place clearly on the attached assembly instructions and return it to us.

SK Vážení zákazník, keby chýbala nejaká časť, alebo by bola poškodená, označte ju prosím krížikom na montážnom návode a zašlite návod spolu s reklamáciou.

CZ Vážení zákazníku, kdyby chyběla nějaká část nebo byla poškozená, označte ji prosím křížkem na montážním návodu a zašlete návod spolu s reklamací.

IT Gentile cliente. In caso di parti mancanti o danneggiate, contrassegnare la parte con una croce sulle istruzioni di montaggio e inviare le istruzioni insieme al reclamo.

FR Cher client, si une pièce est manquante ou endommagée, veuillez marquer la pièce d'une croix sur la notice de montage et envoyer la avec votre réclamation.

BAG 1

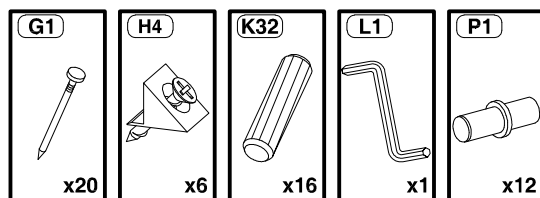

BAG 2

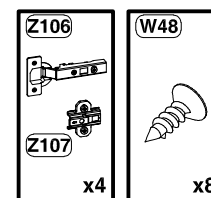

BAG 3

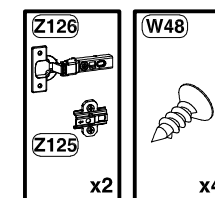

BAG 4

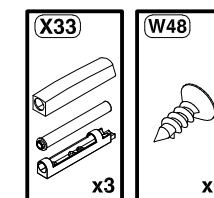

BAG 5

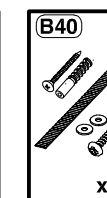

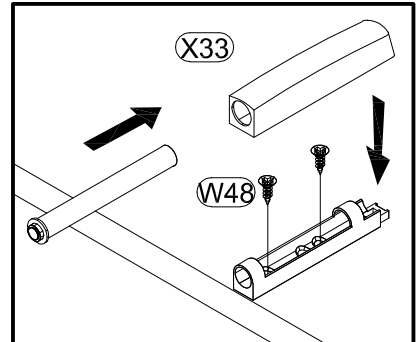
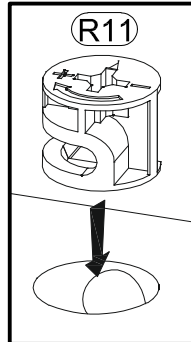
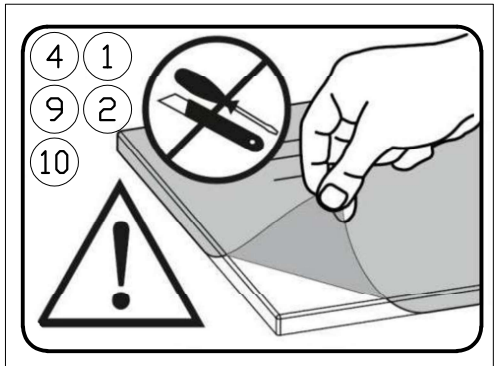
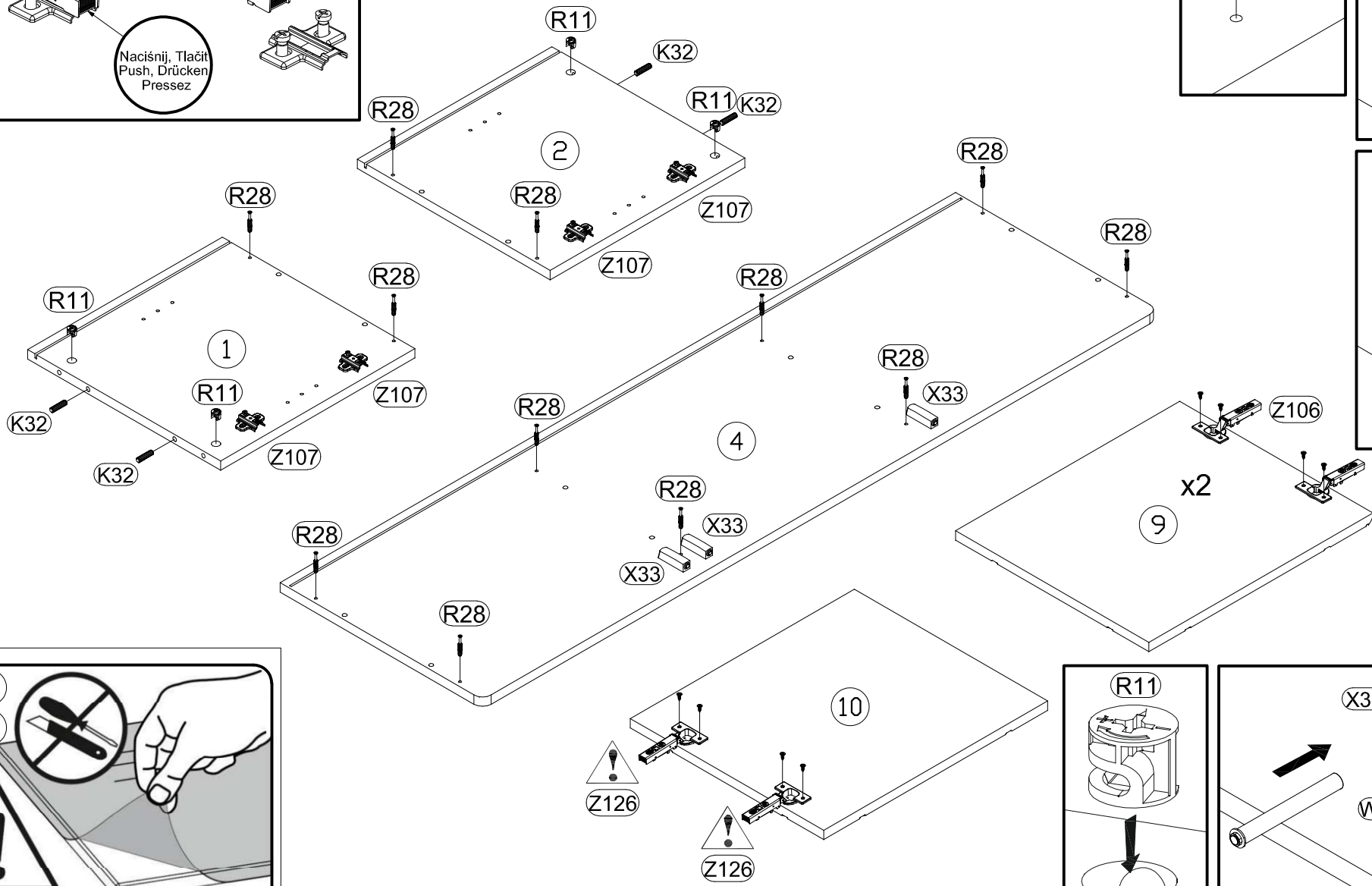
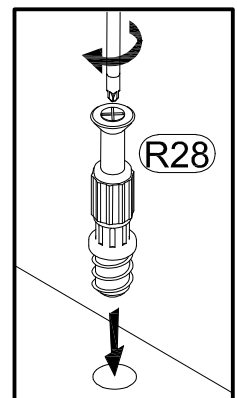
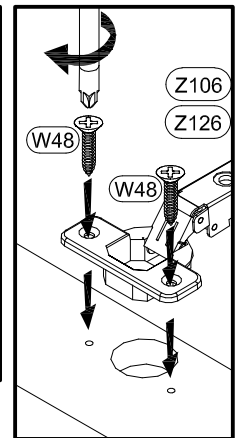
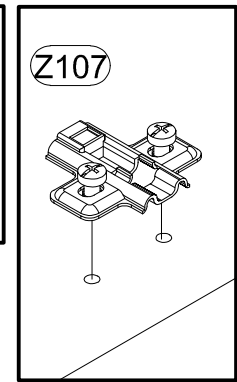
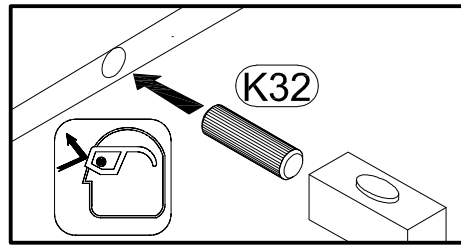
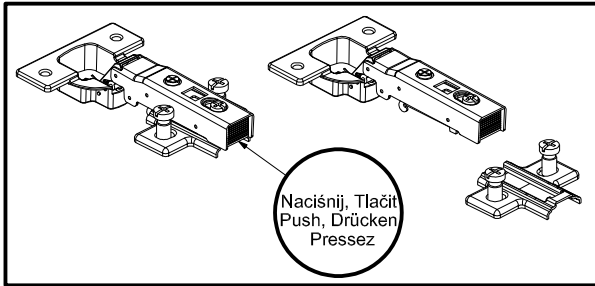

Model: SONATIA RTV 150 3D
Modell: SONATIA RTV 150 3D1SZ
Modell: SONATIA RTV 150 3D2SZ

Strona:
Blatt Nr: 3/10

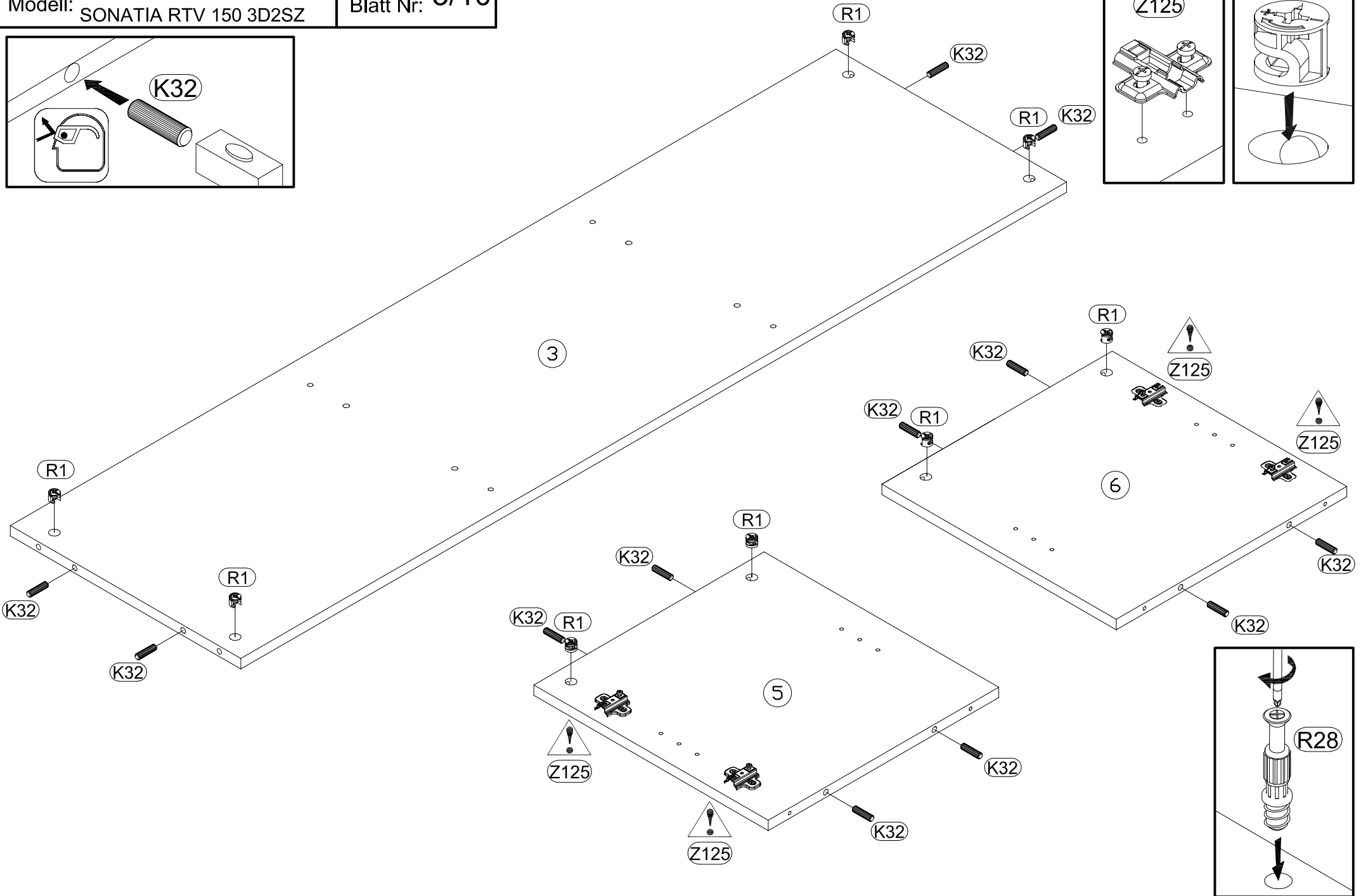
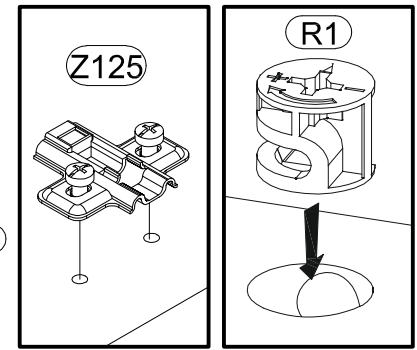
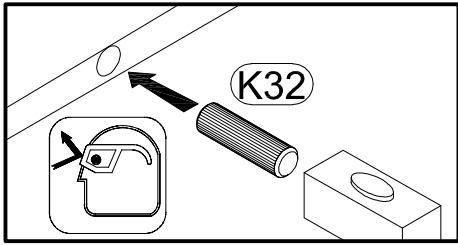

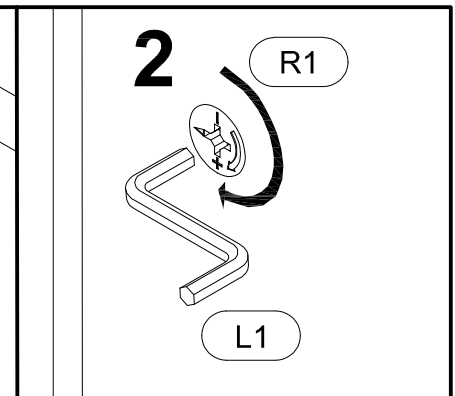
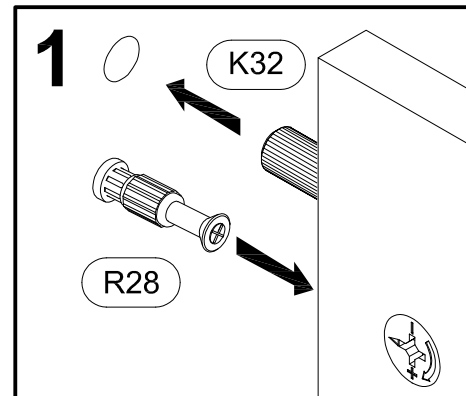
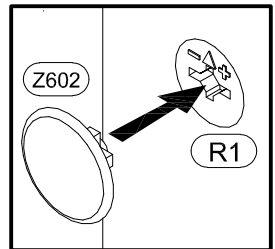
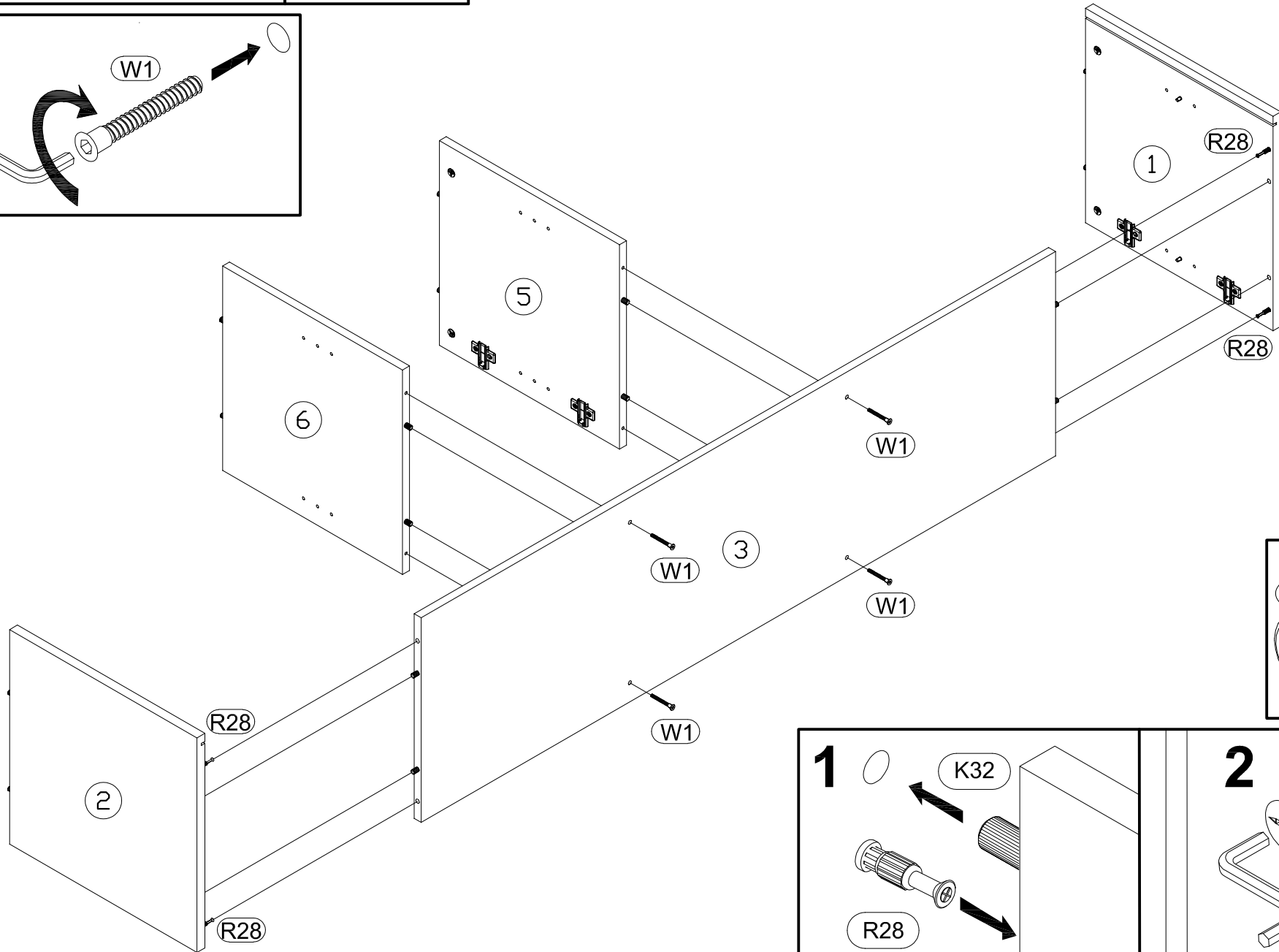
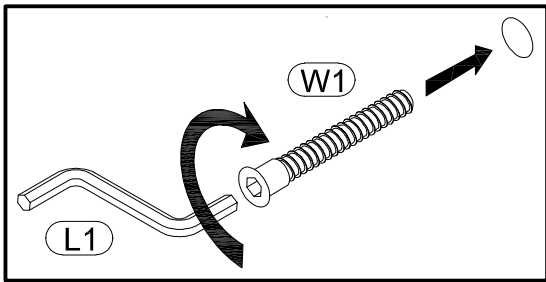

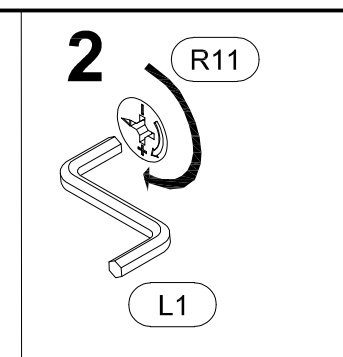
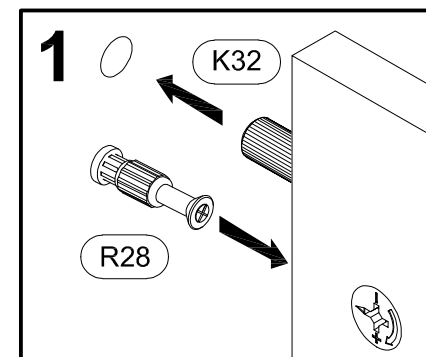
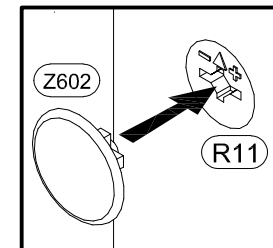
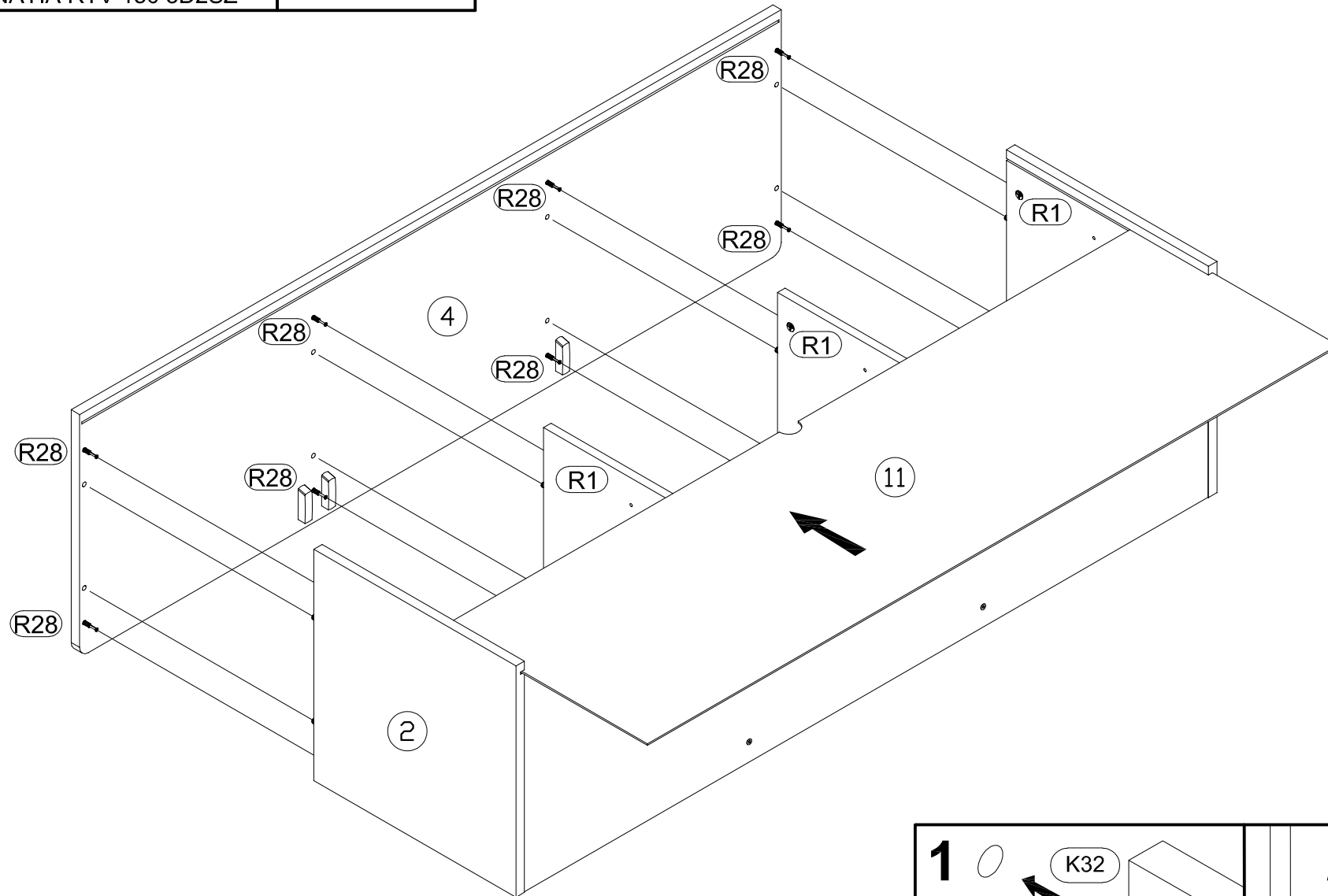

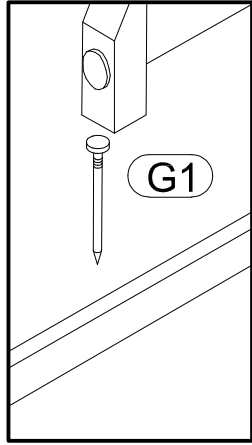

G1

H4

H4

H4

H4

H4

H4

H4

2

H4

H4

H4

H4

H4

H4

H4

H4

H4

H4

H4

G1

G1

G1

G1

G1

G1

G1

G1

G1

G1

G1

G1

G1

G1

G1

G1

G1

G1

G1

G1

G1

G1

G1

G1

G1

G1

G1

G1

G1

3

G1

G1

G1

G1

G1

G1

G1

G1

G1

G1

G1

G1

G1

G1

G1

G1

G1

G1

G1

G1

G1

G1

G1

G1

G1

G1

G1

G1

G1

G1

G1

G1

G1

G1

G1

G1

G1

G1

G1

G1

G1

G1

G1

G1

G1

G1

G1

G1

G1

G1

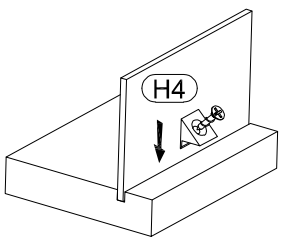

H4

H4

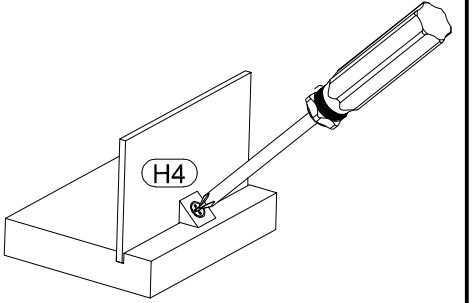

H4

Bardzo ważne! Very important!
Sehr wichtig! Velmi důležitě!
Très important !

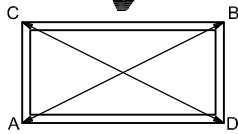

AB=CD

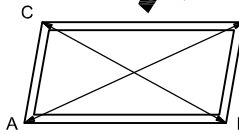

AB>DC

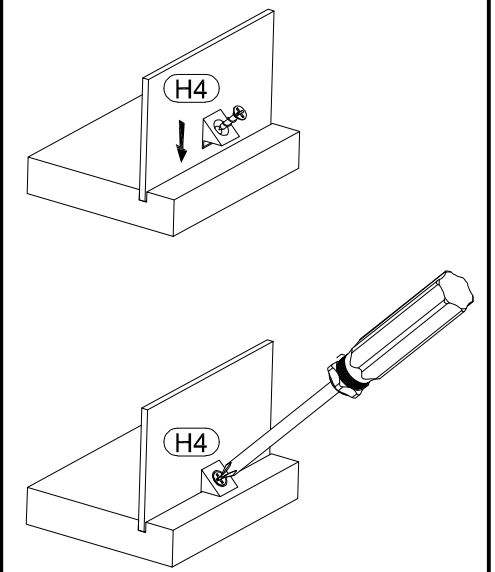

H4

H4

Model: SONATIA RTV 150 3D
Modell: SONATIA RTV 150 3D1SZ
SONATIA RTV 150 3D2SZ

Strona: 7/10
Blatt Nr: 7/10

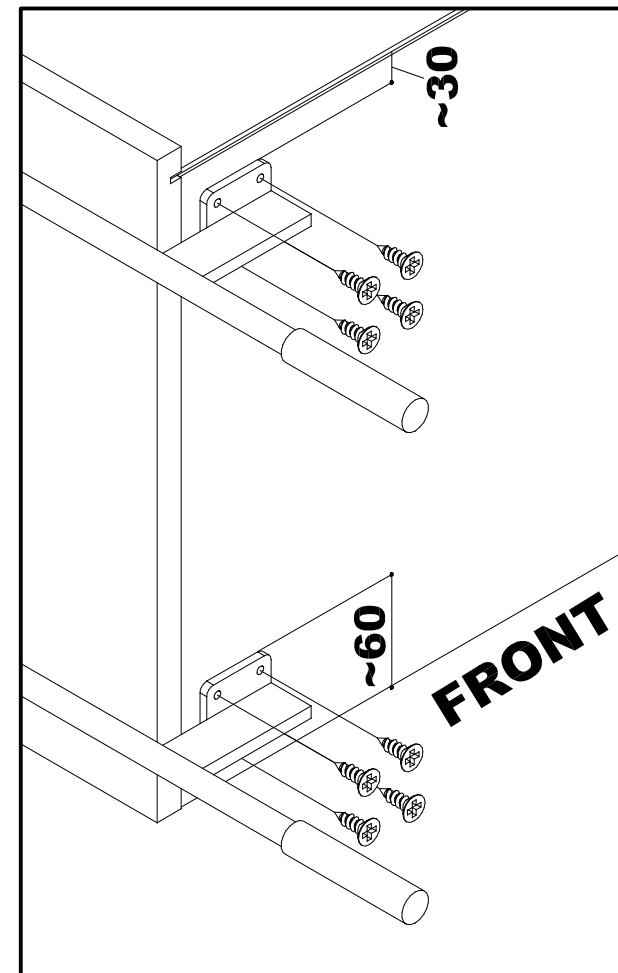
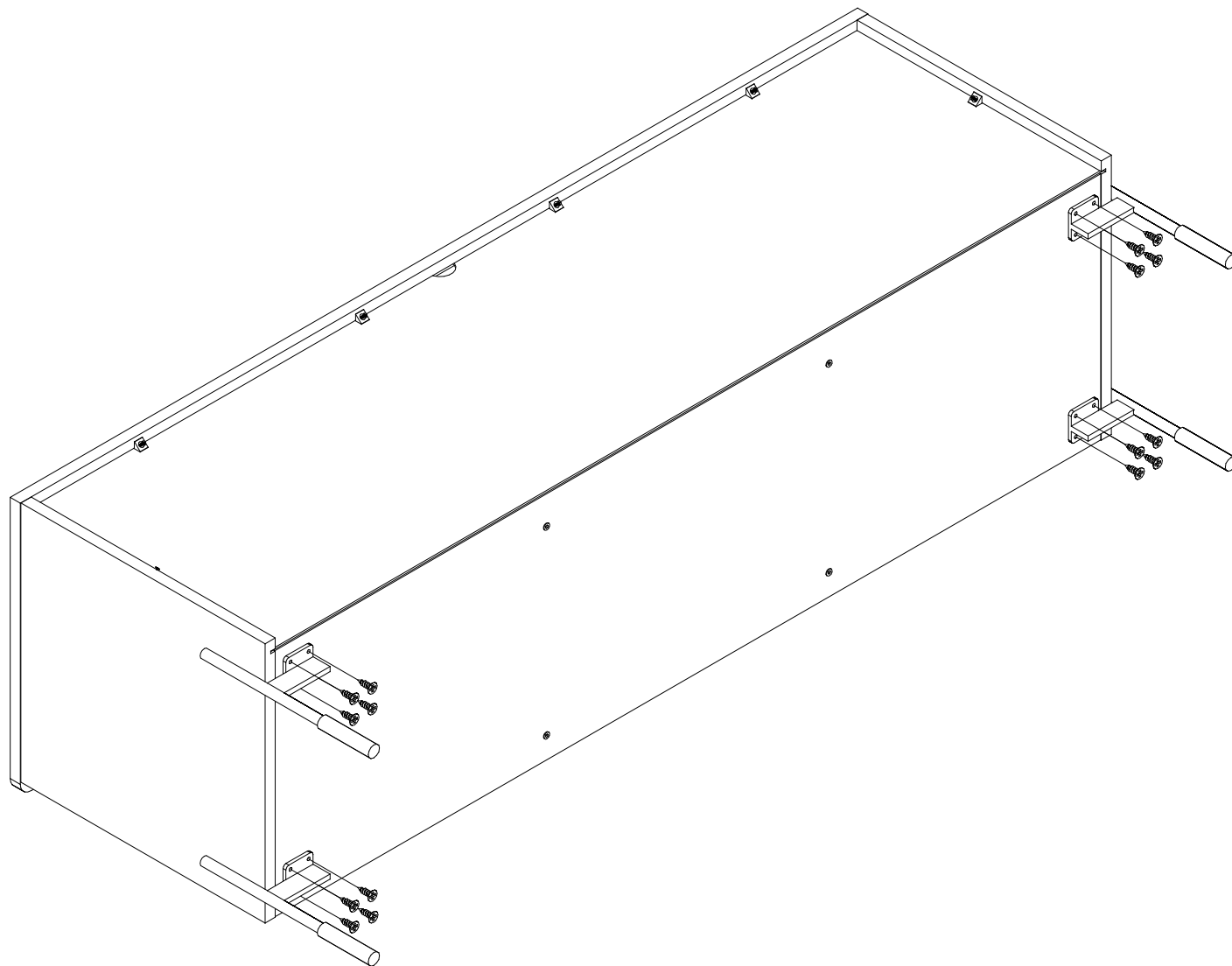

Model: SONATIA RTV 150 3D
Modell: SONATIA RTV 150 3D1SZ
SONATIA RTV 150 3D2SZ

Strona: 8/10
Blatt Nr: 8/10

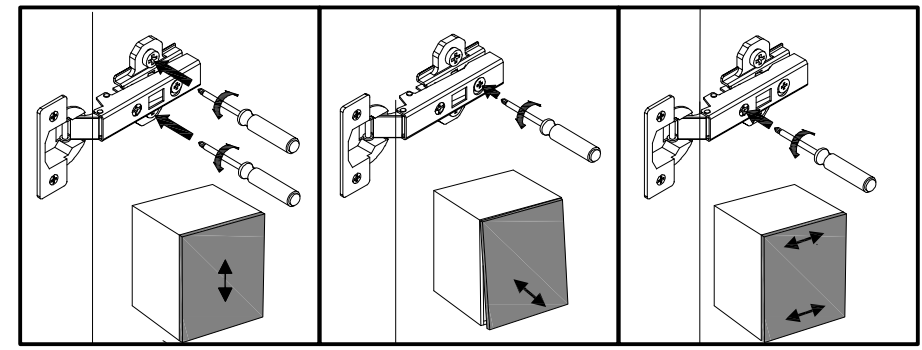
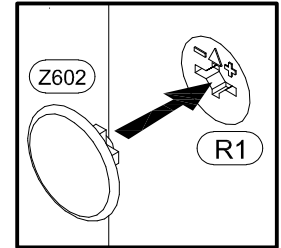
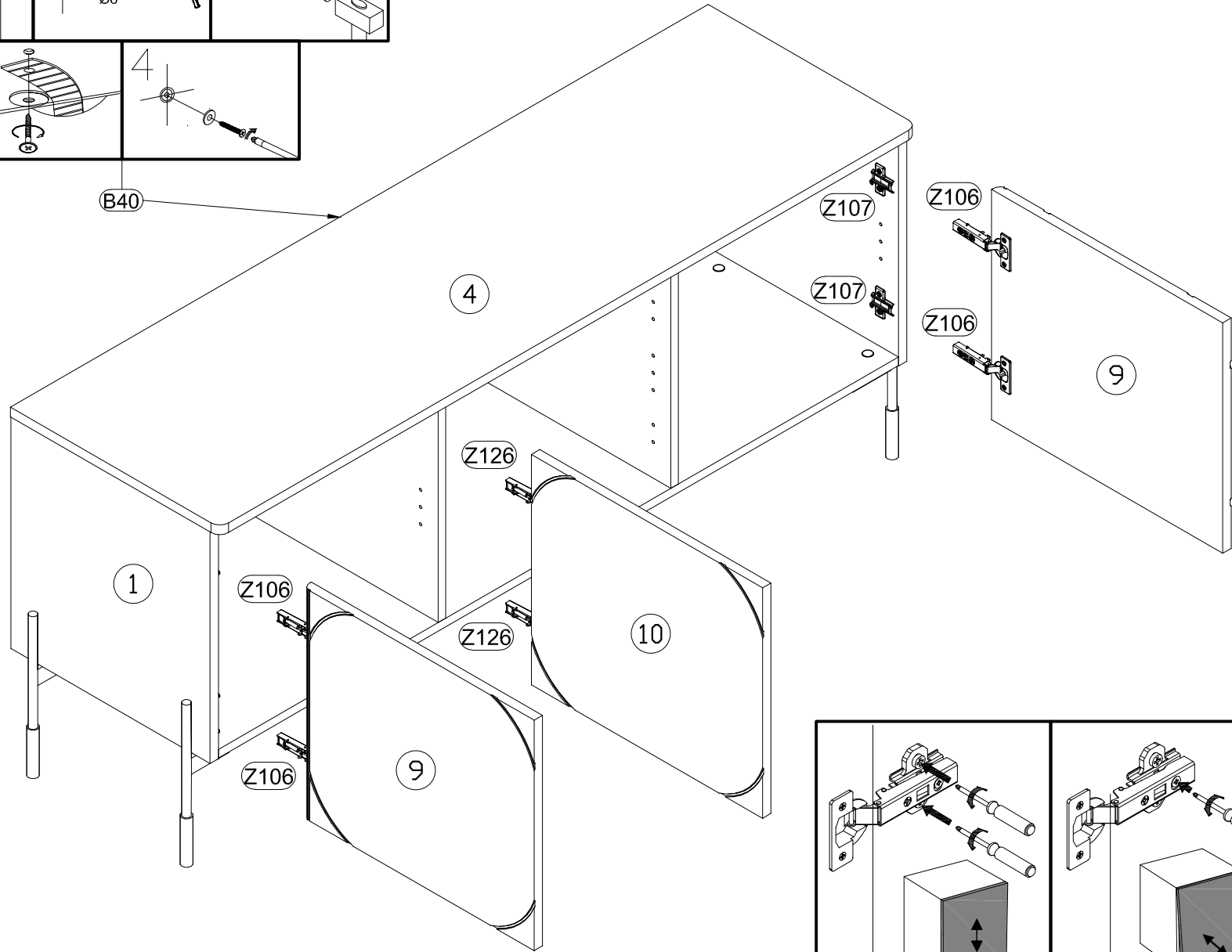
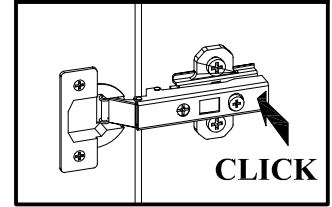
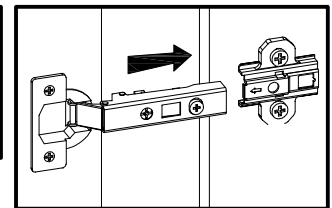
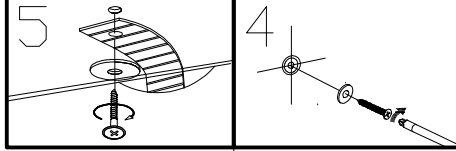
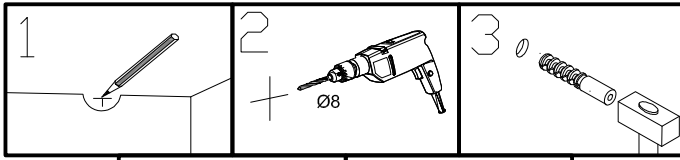
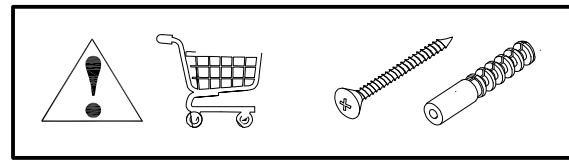

SONATIA RTV 150 3D

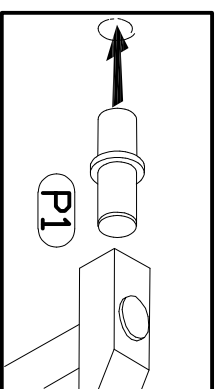
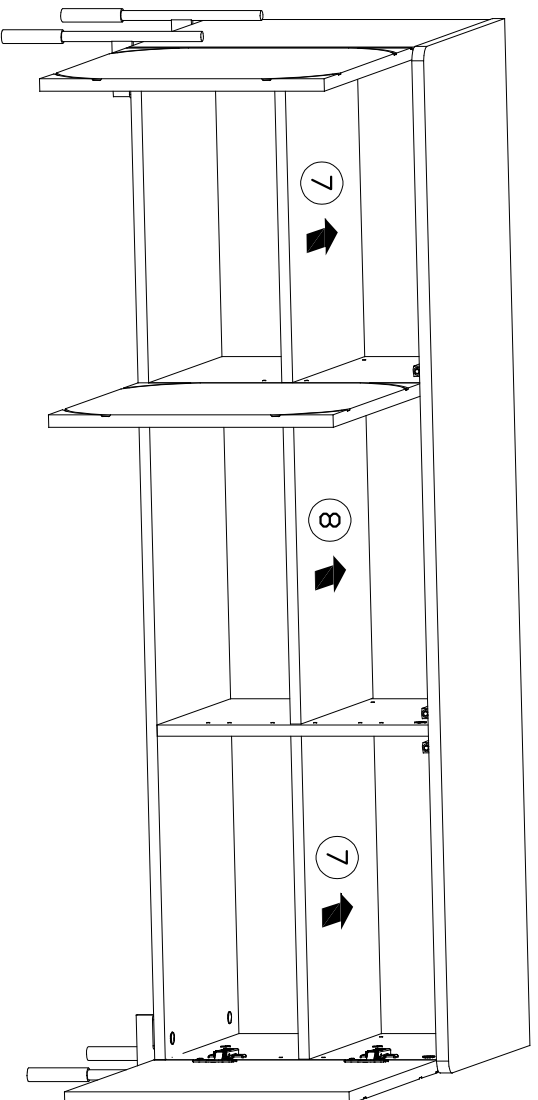

SONATIA RTV 150 3D2SZ

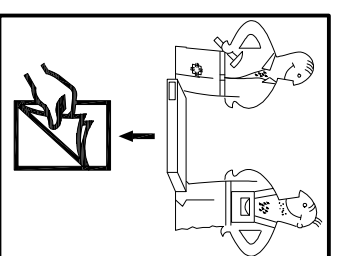
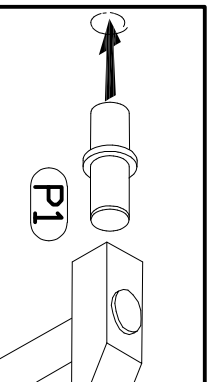
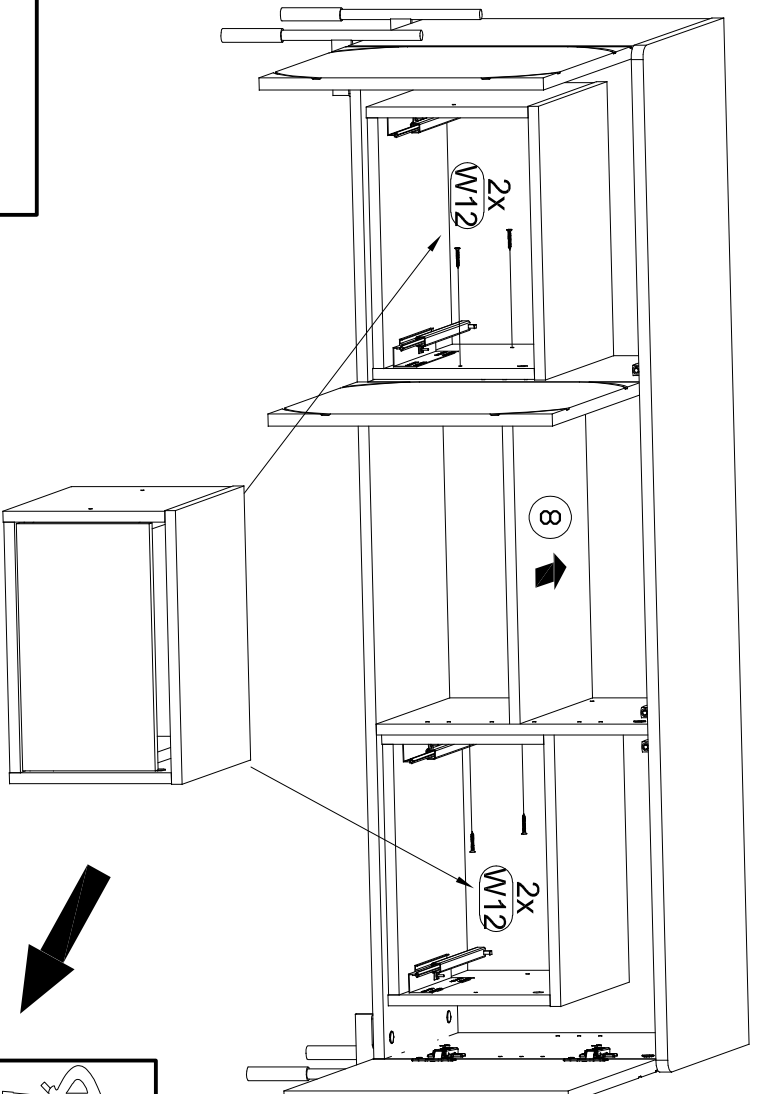

SONATIA RTV 150 3D1SZ L

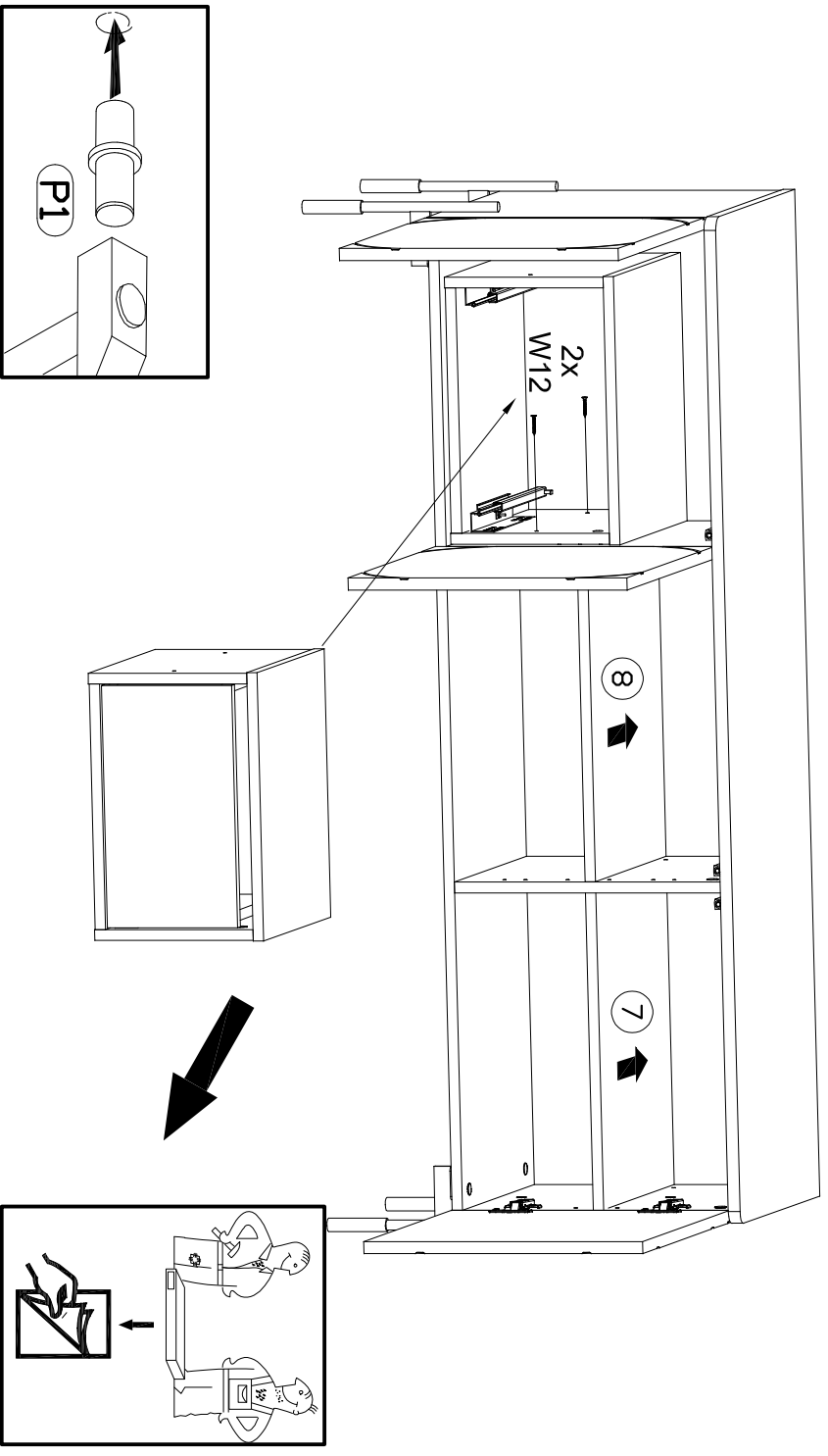

SONATIA RTV 150 3D1SZ P

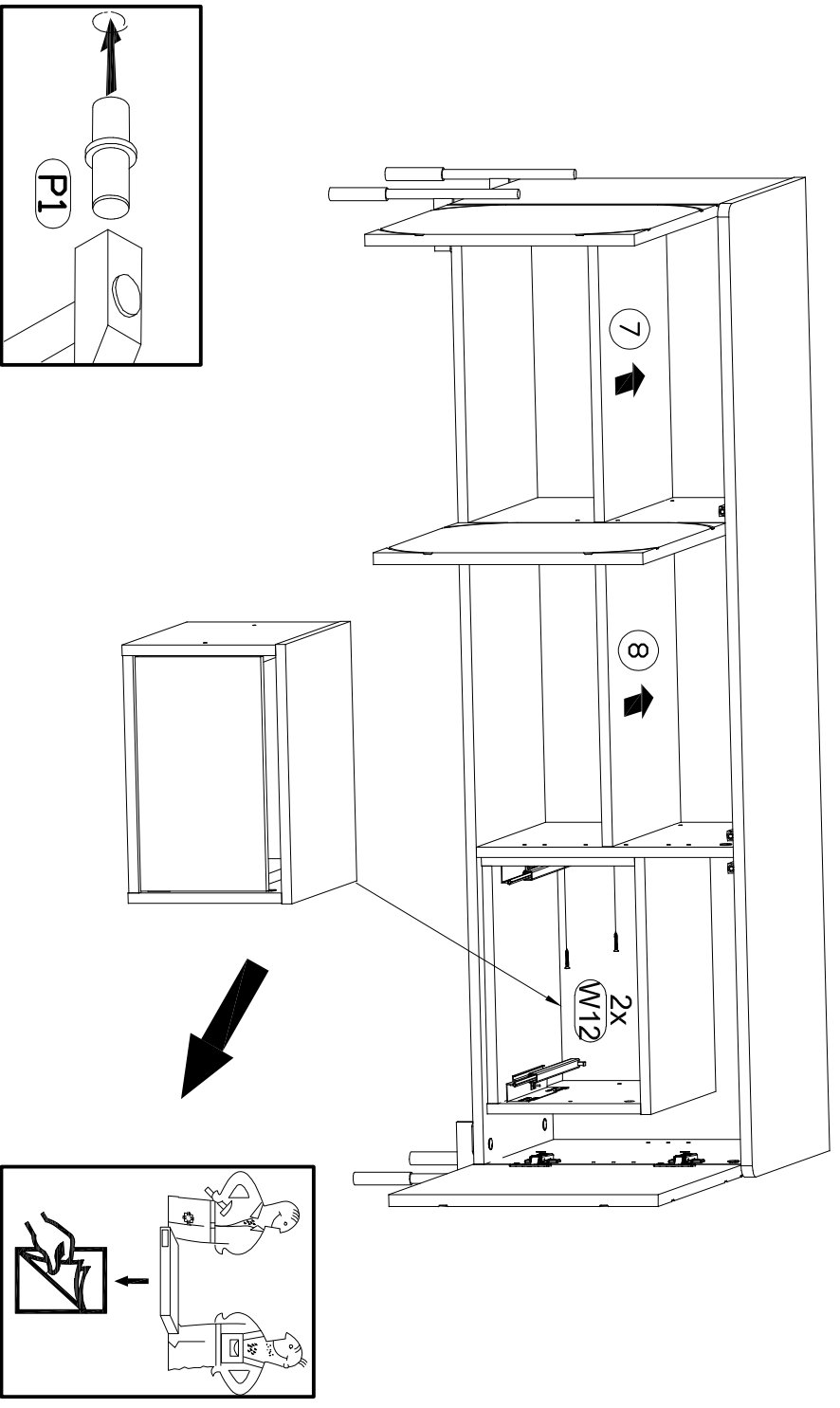

Model: SONATIA
Modell: KONTENEREK 40 1SZ

Strona: 1/6
Blatt Nr:

BOGART.

Do montażu potrzebne są:

Für die Montage dieser Type benötigen Sie:

For assembly you need:

Pour le montage, vous avez besoin de :

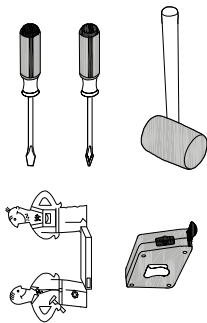

(PL) INSTRUKCJA MONTAŻOWA
(D) MONTAGENLEITUNG
(GB) ASSEMBLY INSTRUCTIONS
(SK) NÁVOD NA MONTÁŽ
(CZ) MONTÁŽNÍ NÁVOD
(IT) ISTRUZIONI DI ASSEMBLAGGIO
(FR) NOTICE DE MONTAGE

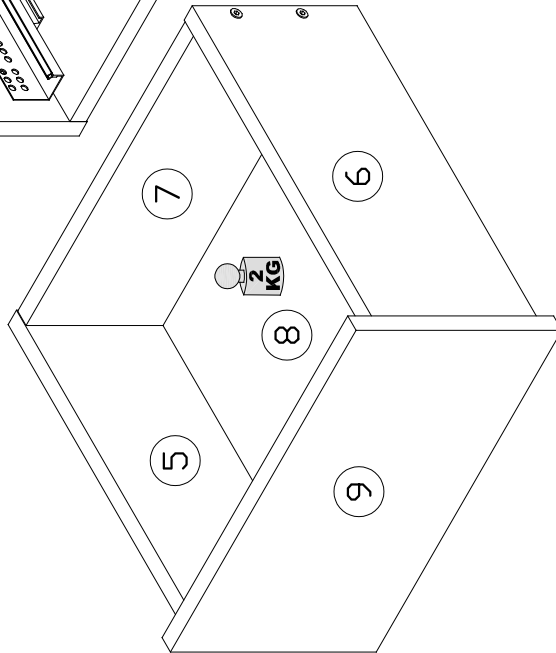
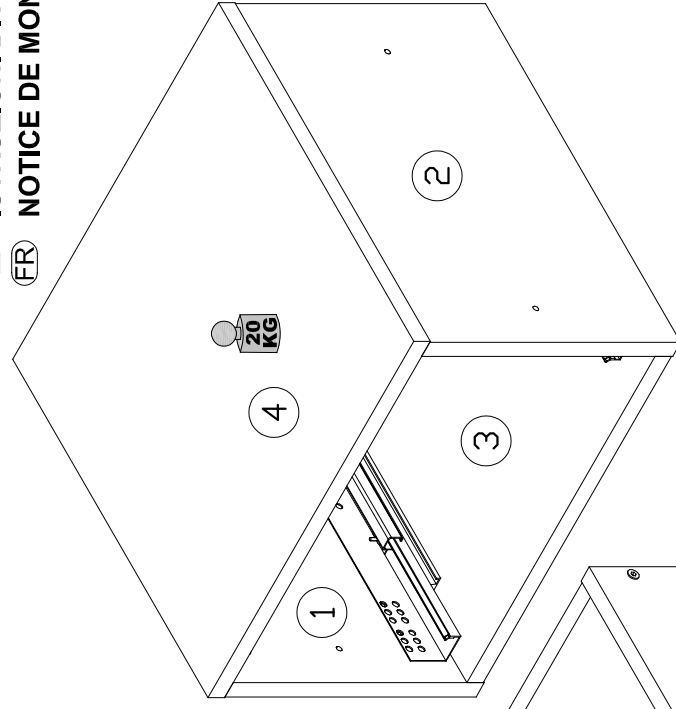
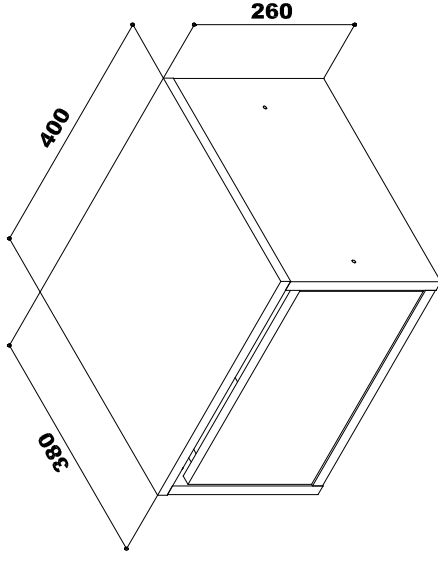

PL Szanowny Kliencie. Gdyby brakowało jakiegó części lub była by uszkodzona, to proszę oznaczyć część krzyżykiem na instrukcji montażowej i przesać instrukcję razem z reklamacją.

D Sehr geehrter Kunde. Sollte ein Teil fehlen oder beschadigt sein, kreuzen Sie bitte dieses deutlich auf der Montageanleitung an und schicken Sie zu uns ab.

GB Dear customer. Should there be any place missing or damaged, kindly mark this place clearly on the attached assembly instructions and return it to us.

SK Vážení zákazník, keby chýbala nejaká časť, alebo by bola poškodená, označte ju prosím krížikom na montážnom návode a zašlite návod spolu s reklamáciou.

CZ Vážení zákazníkú kdyby chýbela nějaká část nebo byla poškozená, označte ji prosím křížkem na montážním návodu a zašlete návod spolu s reklamací.

IT Gentile cliente. In caso di parti mancanti o danneggiate, contrassegnare la parte con una croce sulle istruzioni di montaggio e inviare le istruzioni insieme al reclamo

FR Cher client, si une pièce est manquante ou endommagée, veuillez marquer la pièce d'une croix sur la notice de montage et envoyer la avec votre réclamation.

BAG 1

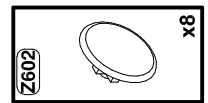
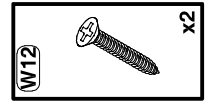
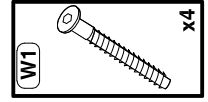
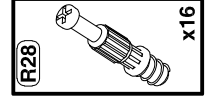
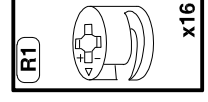
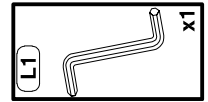
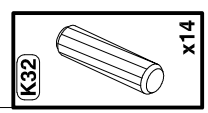

BAG 2

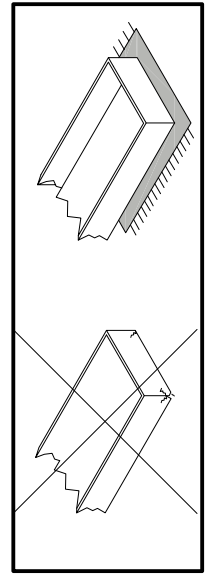
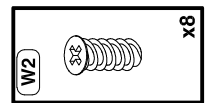
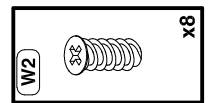
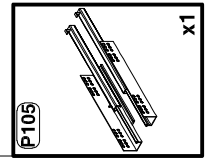

Model: SONATIA
Modell: KONTENEREK 40 1SZ

Strona: 2/6
Blatt Nr:

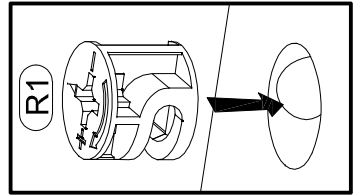
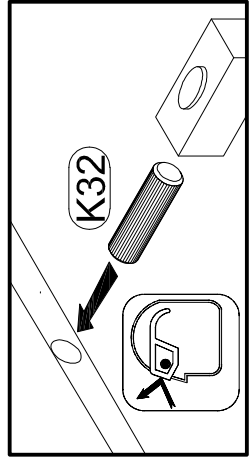
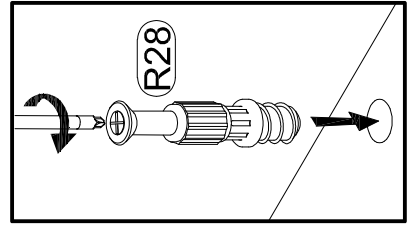
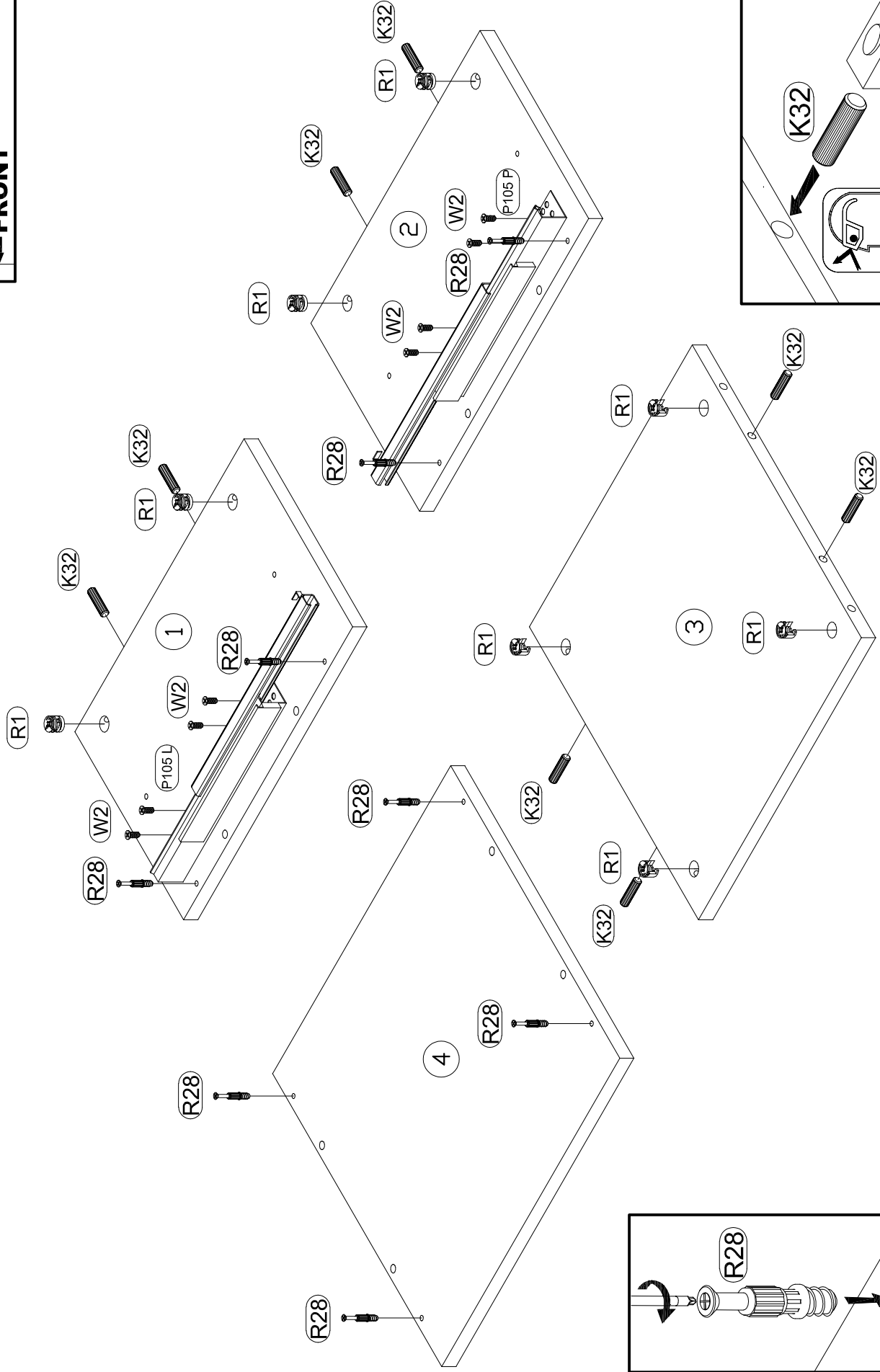
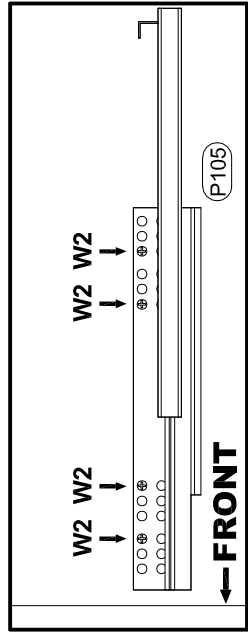

Model: SONATIA
Modell: KONTENEREK 40 1SZ
Strona: 3/6
Blatt Nr:

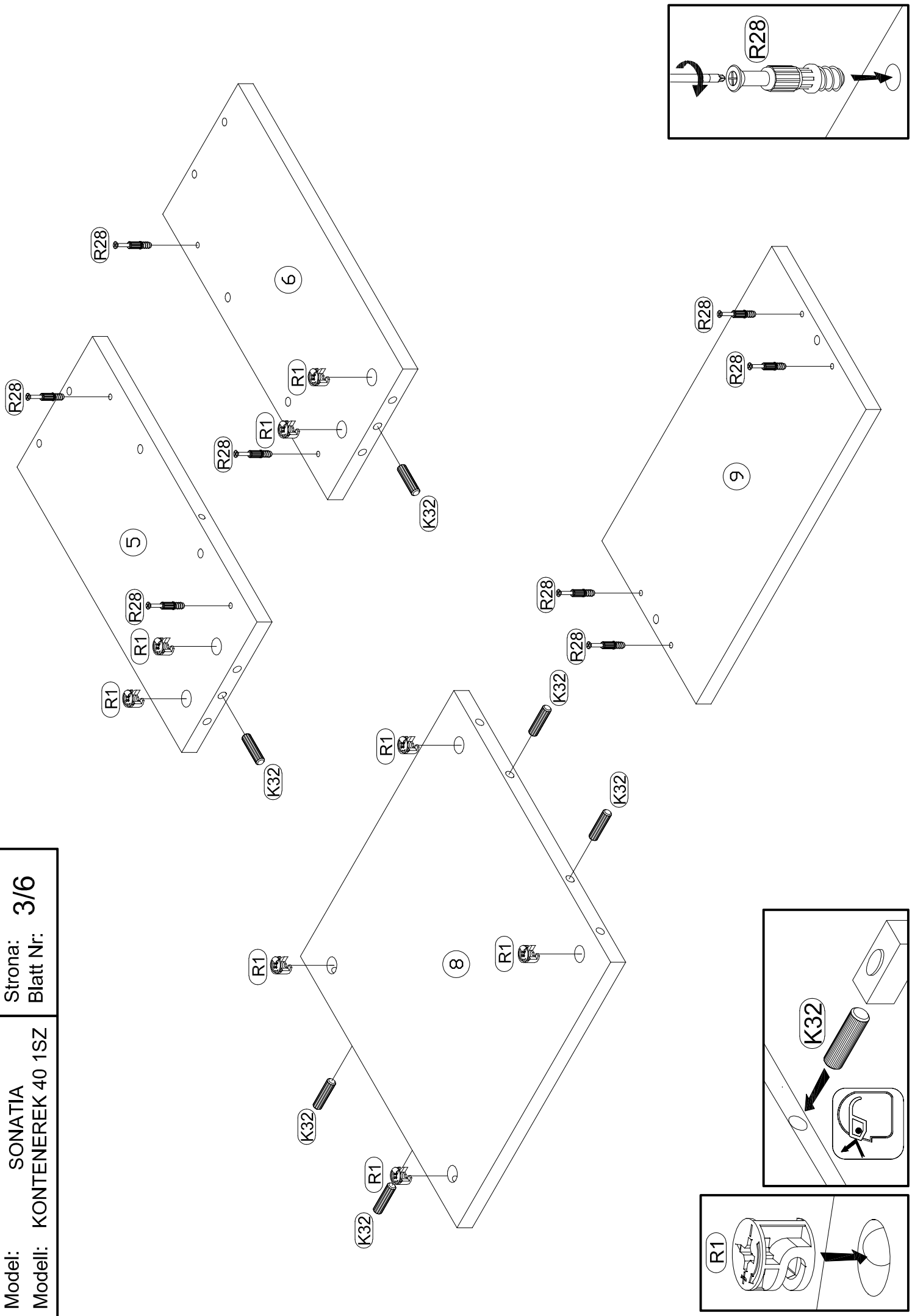

Model: SONATIA
 Modell: KONTENEREK 40 1SZ
 Strona: 4/6
 Blatt Nr:

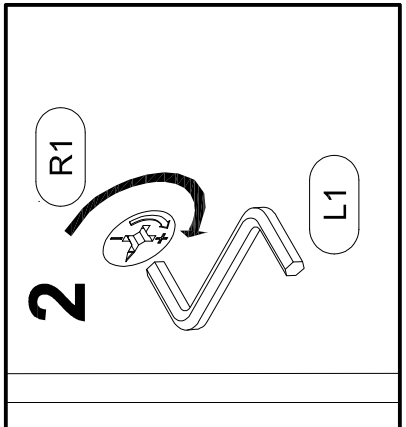
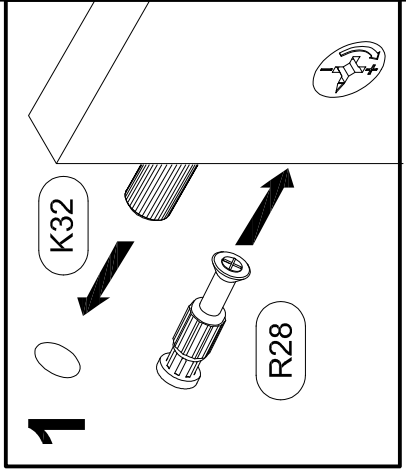
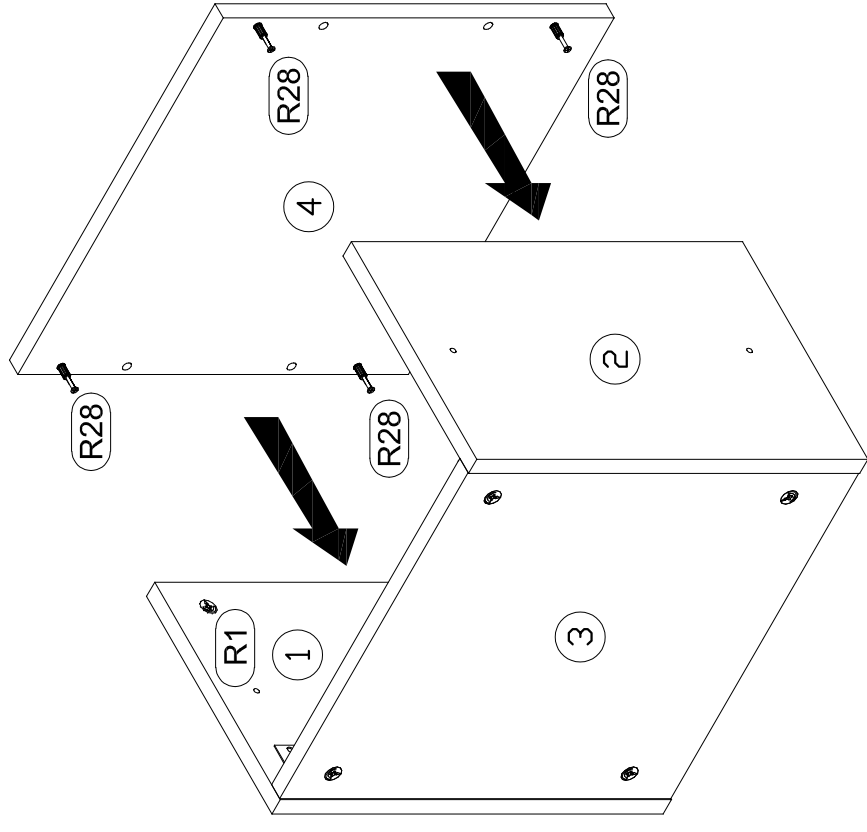
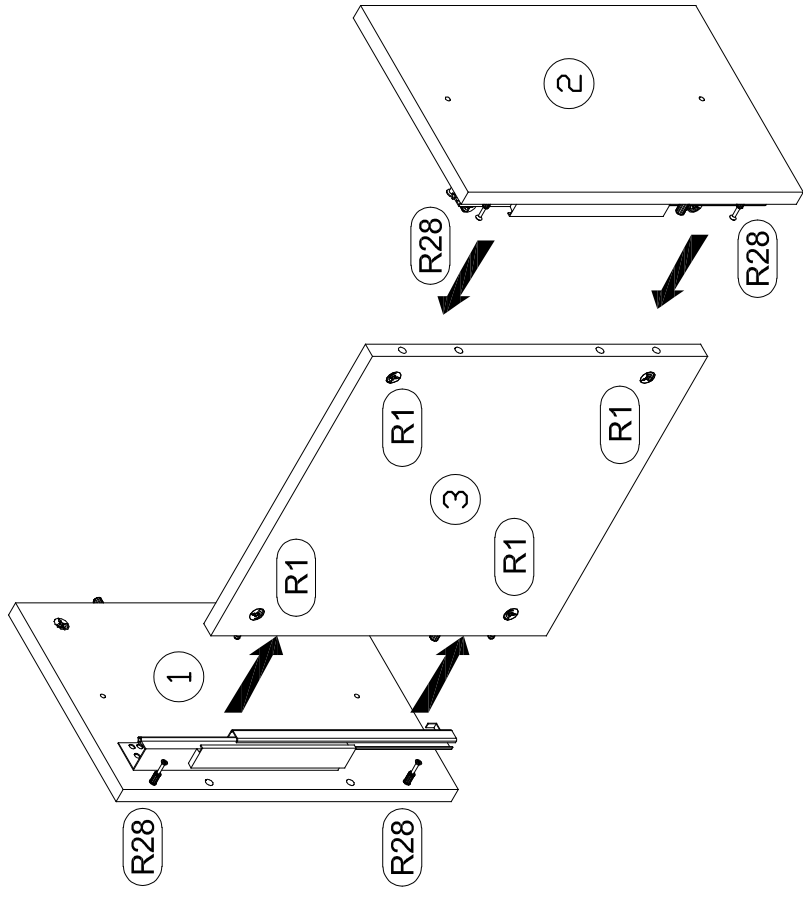

Model: SONATIA
Modell: KONTENEREK 40 1SZ

Strona: 5/6
Blatt Nr:

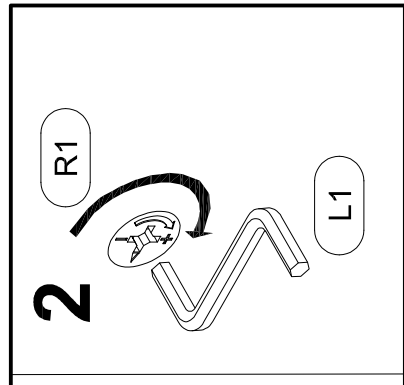
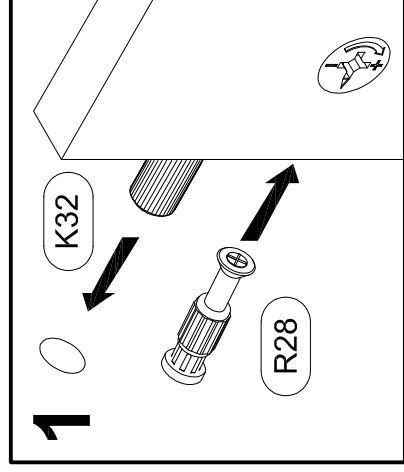
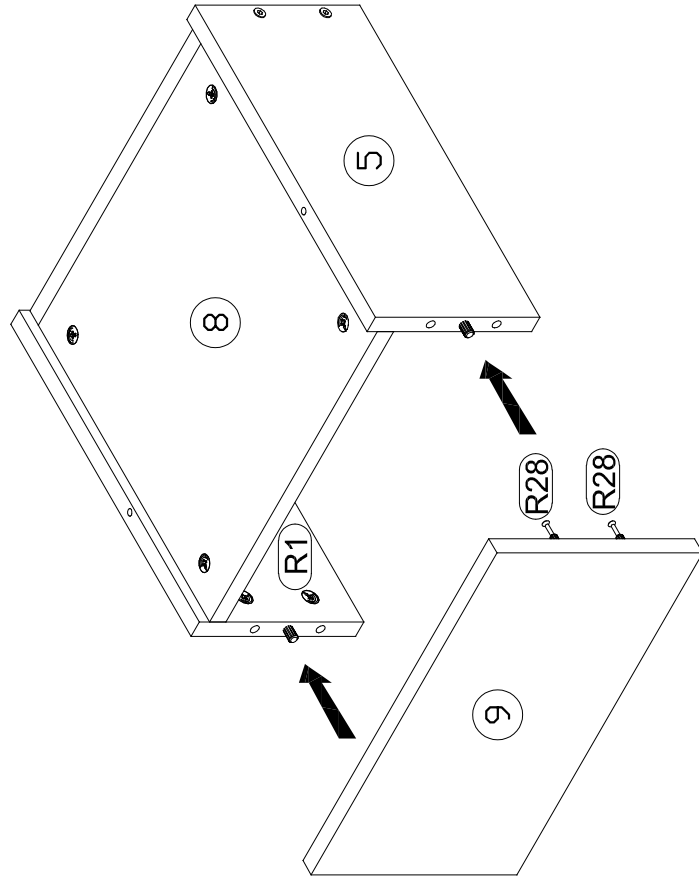
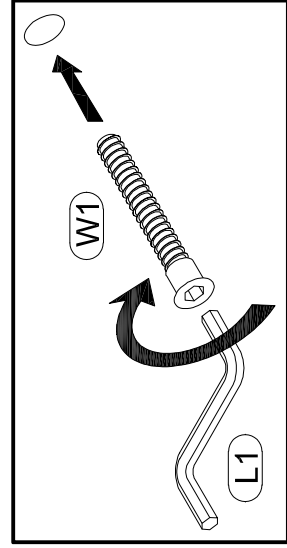
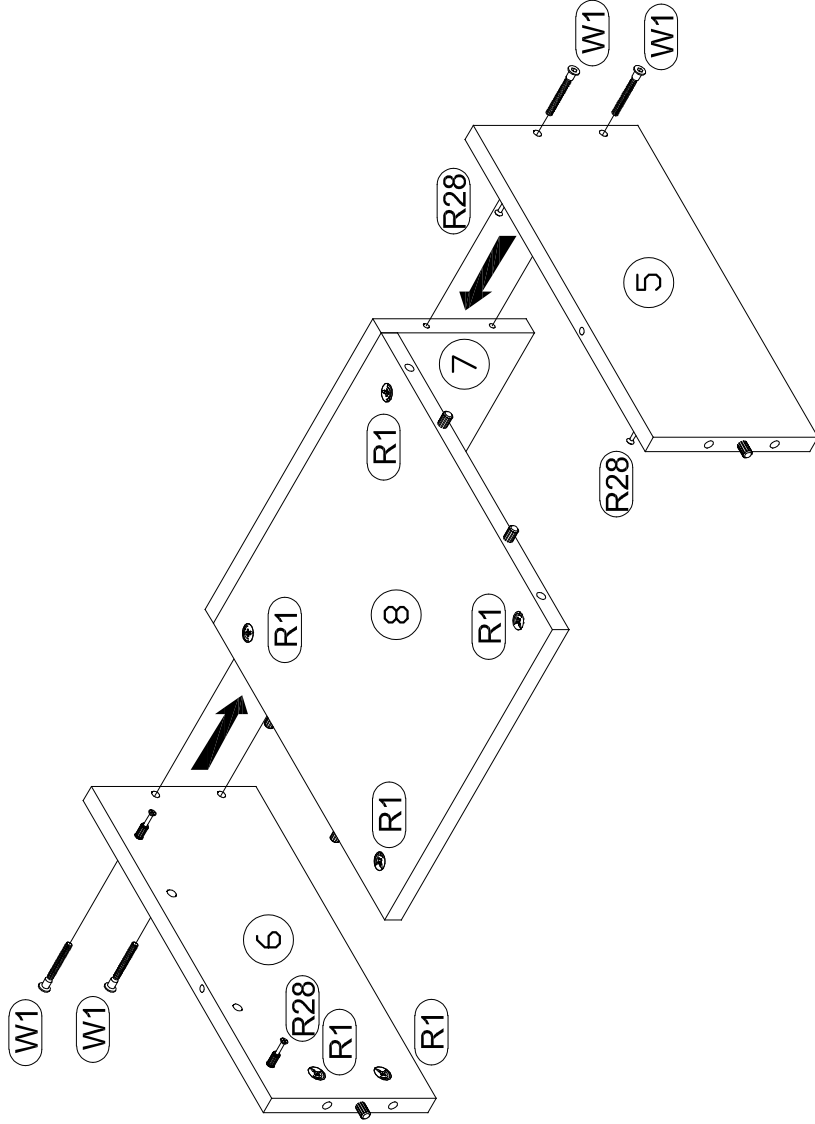

Model: SONATIA
Modell: KONTENEREK 40 1SZ

Strona: 6/6
Blatt Nr:

