

13450173...  
 242702.../13  
 242701.../13  
 5107363  
 5107364  
 5107365  
 5107366

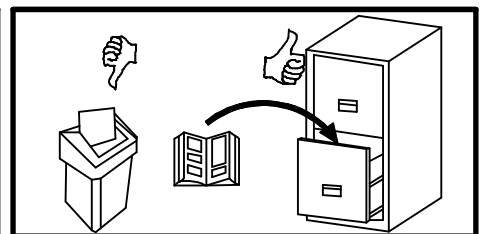

A	B1	B2	C1	C2	C3	D
1	S588-0006	-3	156	446	15	1/1
2	S588-0007	-3	636	446	15	1/1
3	S588-1003	-8	802	382	15	1/1
4	S588-1004	-7	802	382	15	1/1
5	S588-2002	-3	450	400	15	1/1
6	S588-3003	-2	419	360	15	1/1
7	S588-3004	-2	419	360	15	1/1
8	S588-9021	-1	805	429	2,5	1/1
9	WSP-9324	B.53	392	358	2,5	1/1
10	WSR2-5005	-5	350	110	12	1/1
11	WSR2-5006	-5	350	110	12	1/1
12	ZS7-5028	-14	370	110	15	1/1

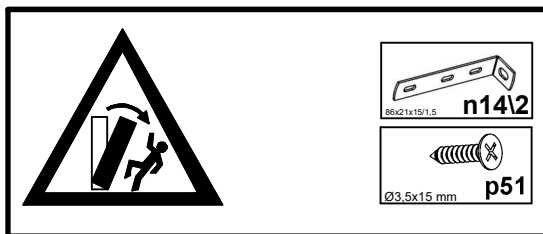

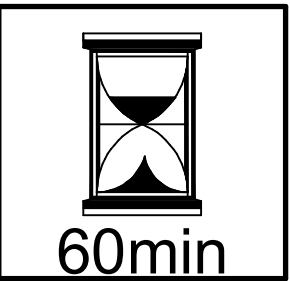
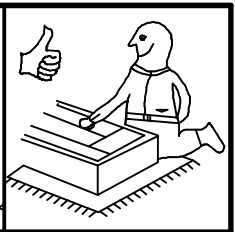
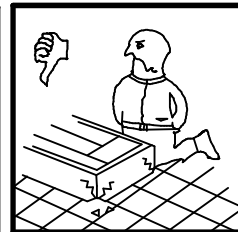
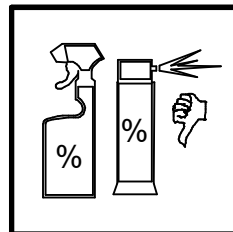
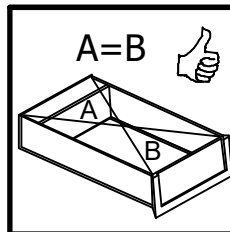
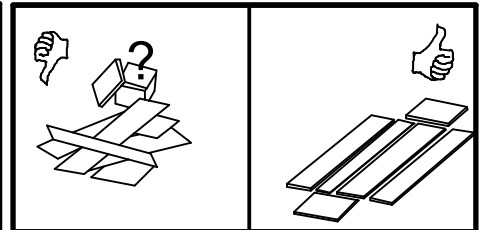
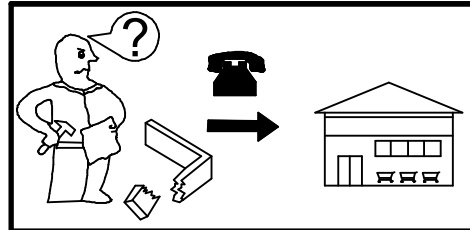
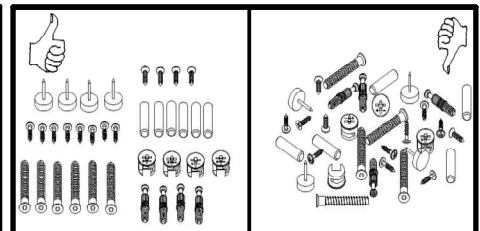
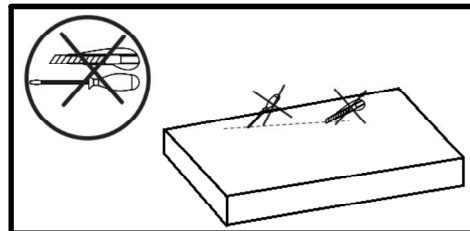
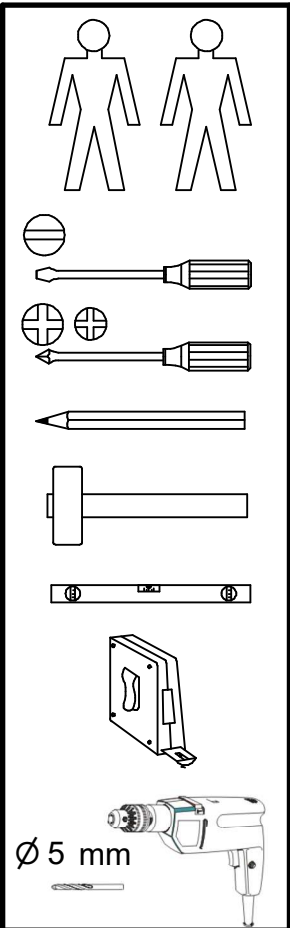
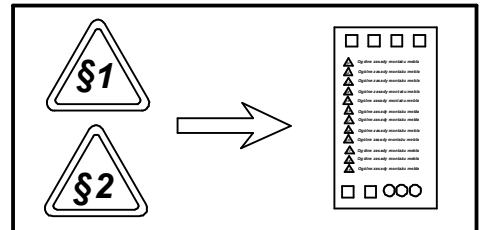
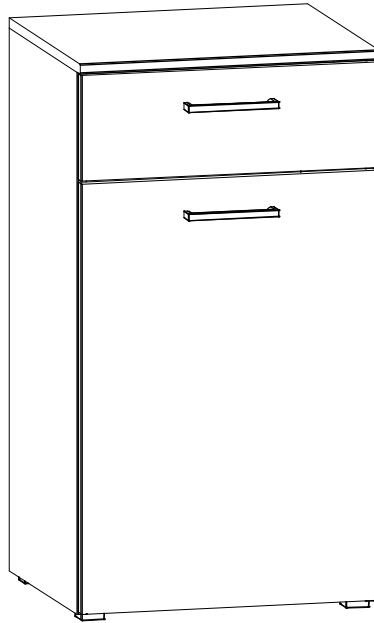
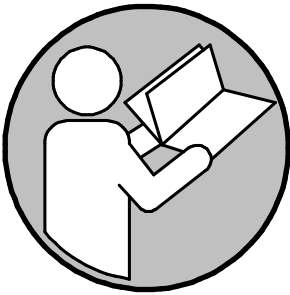
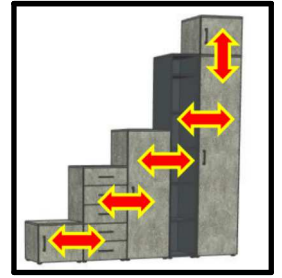
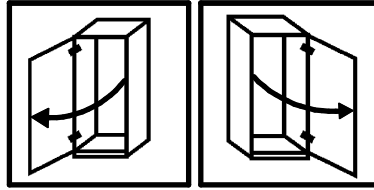
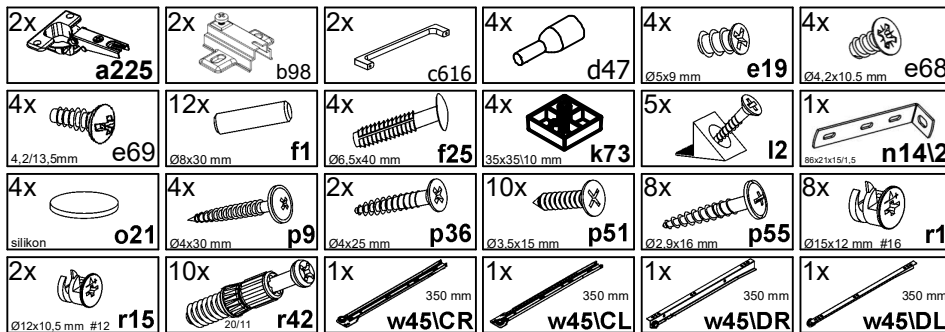
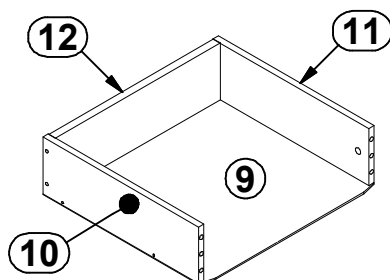
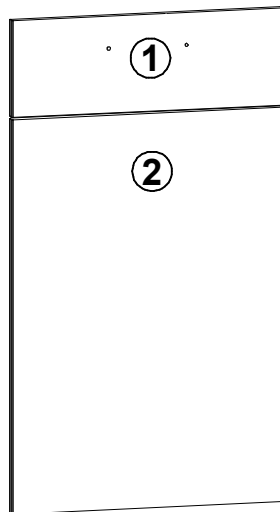
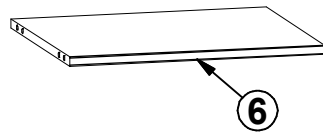
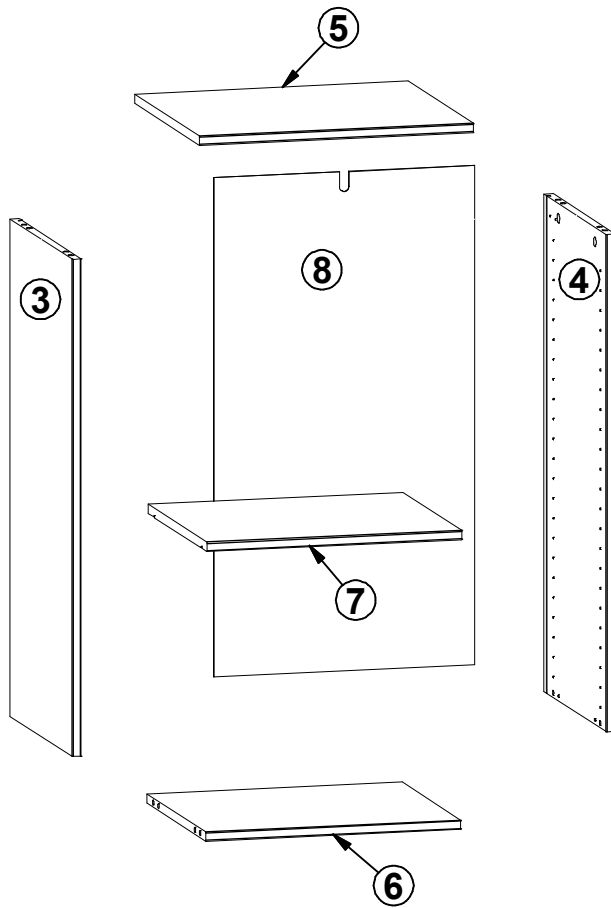

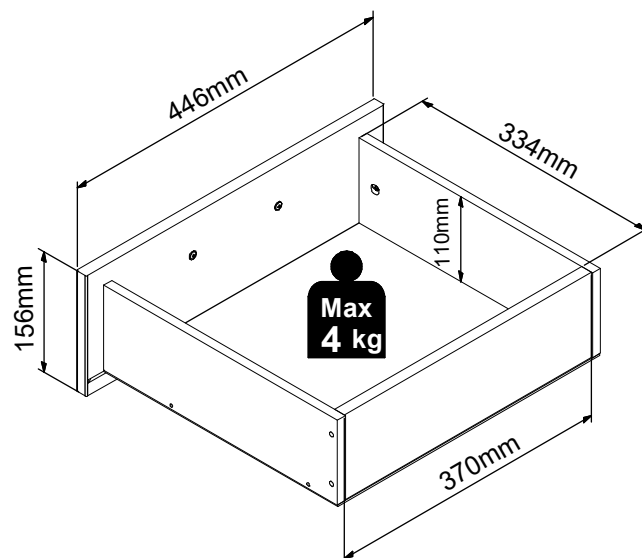
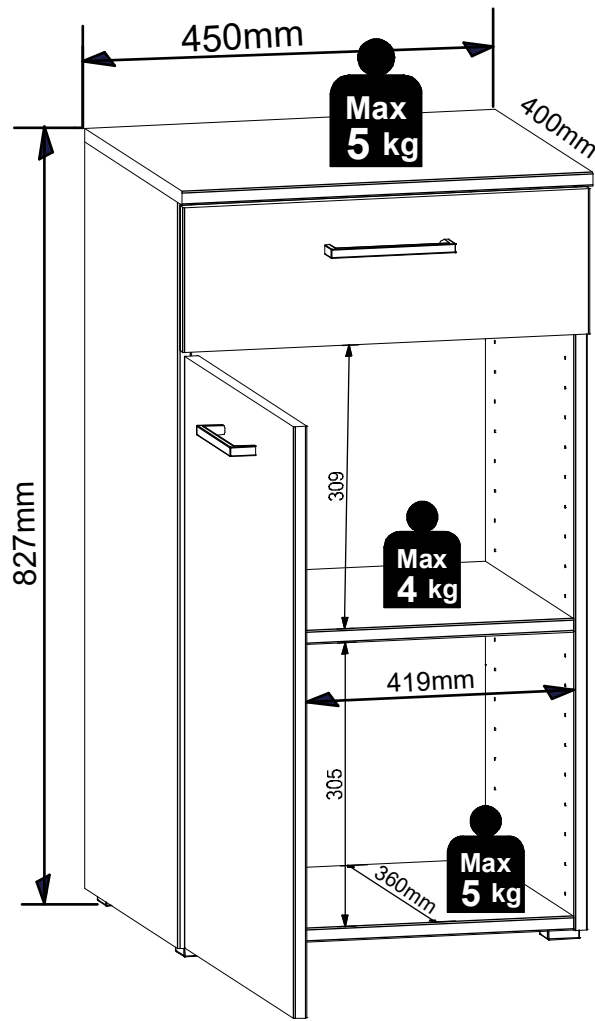

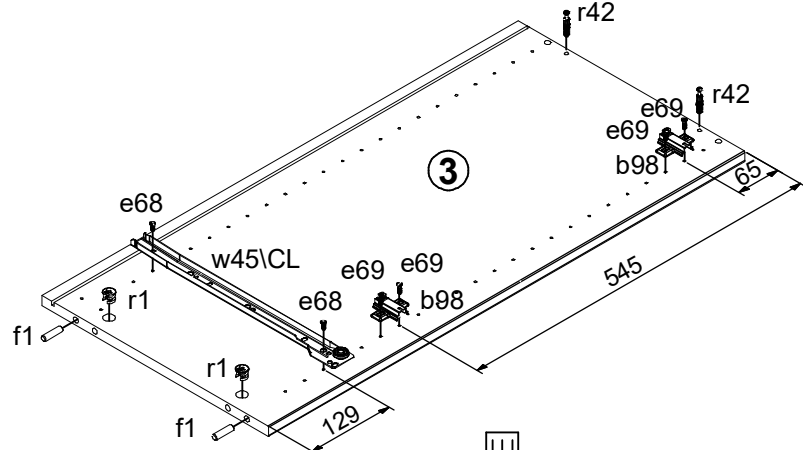
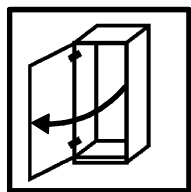
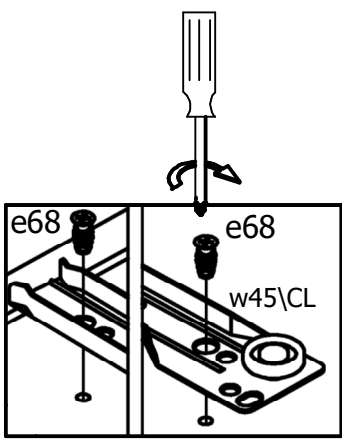
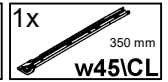
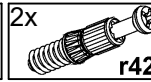
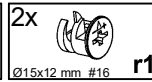
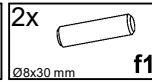
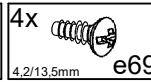
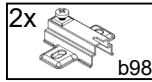

1 ▶

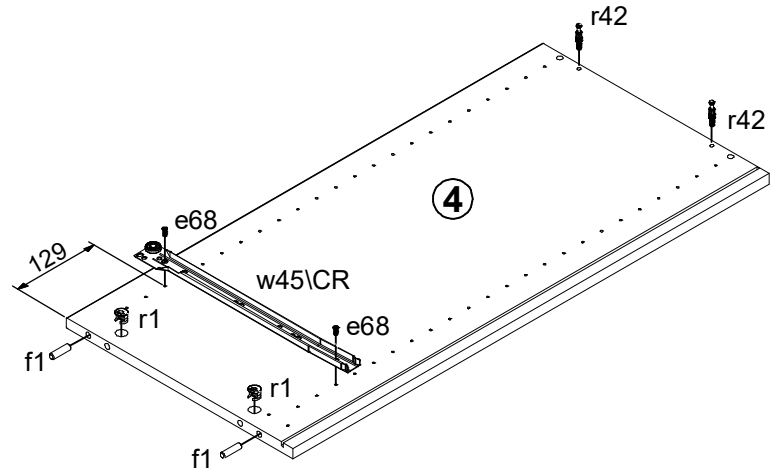
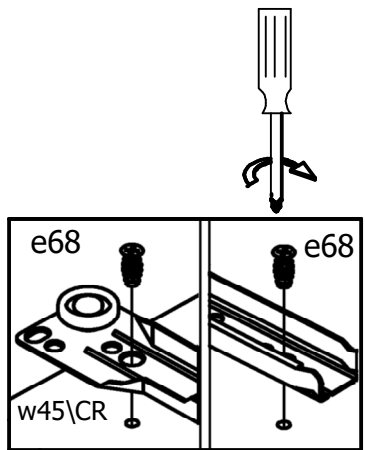
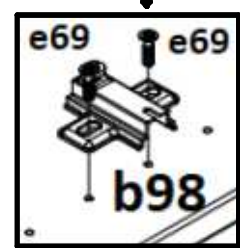
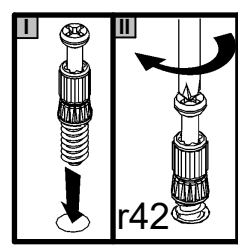
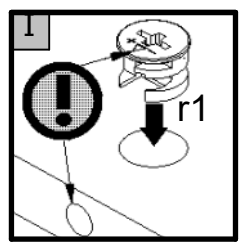
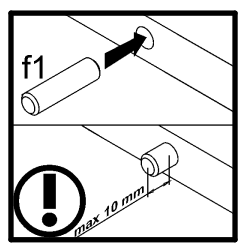

2 ▶

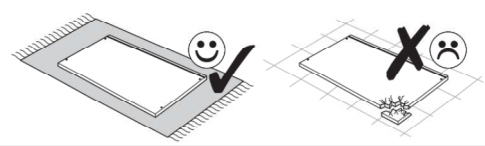
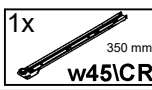
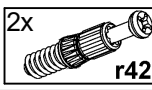
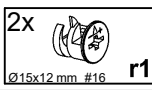
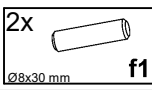
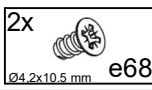

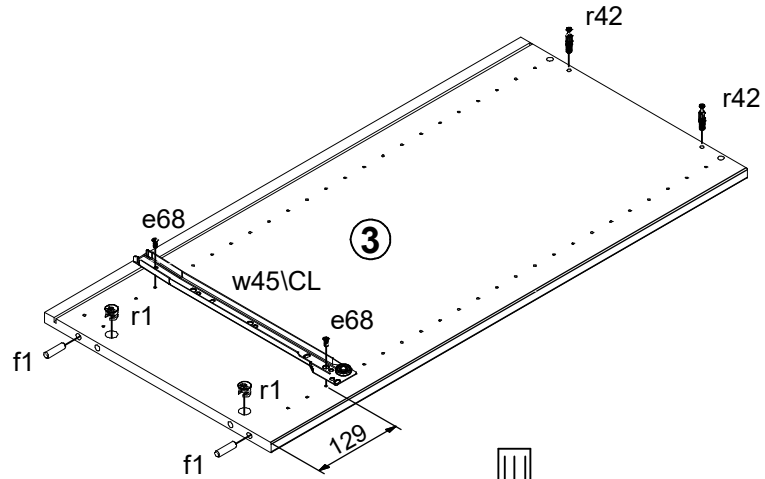
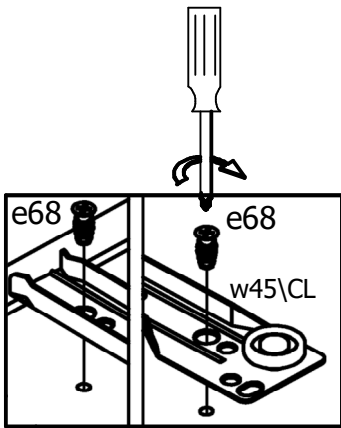
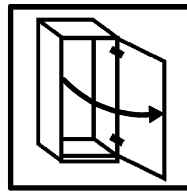
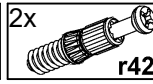
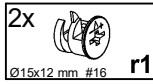
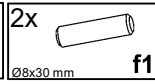
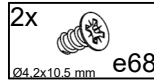

1 ▶

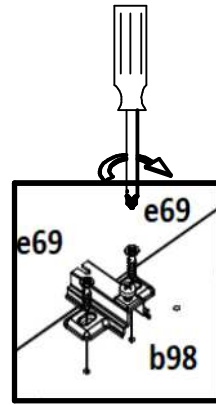
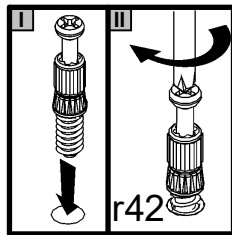
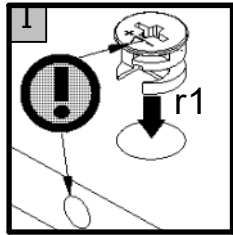
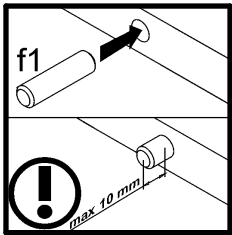

2 ▶

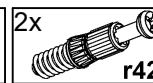
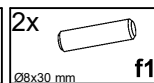
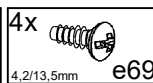
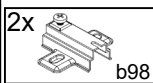
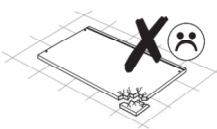
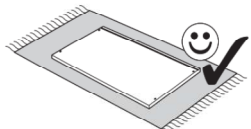
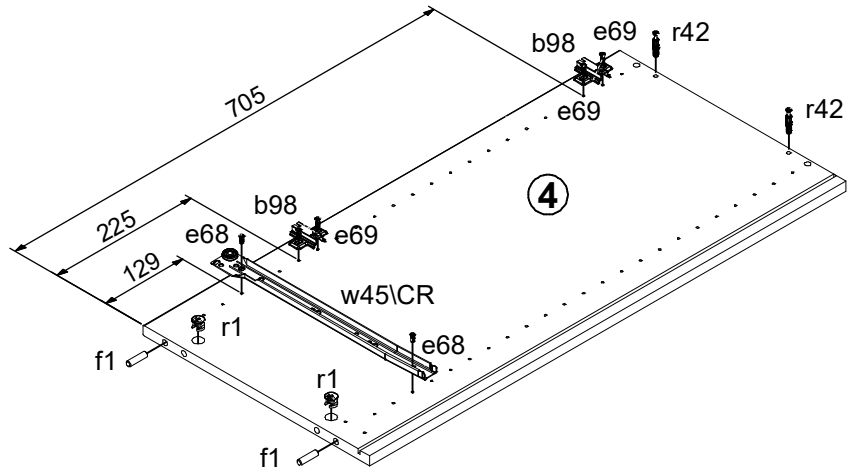
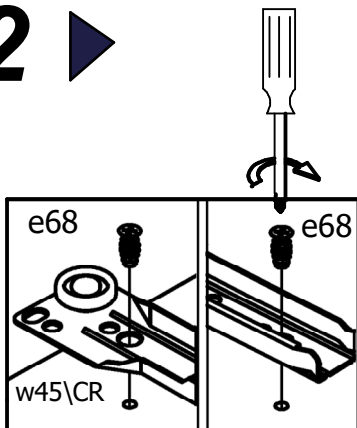

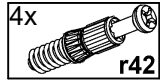

3 ▶

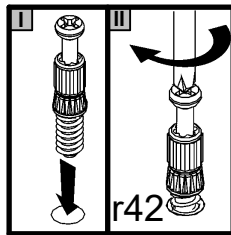
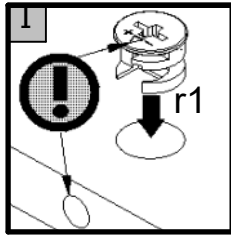
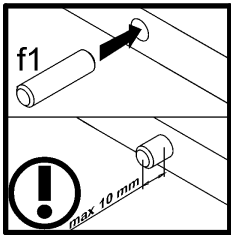
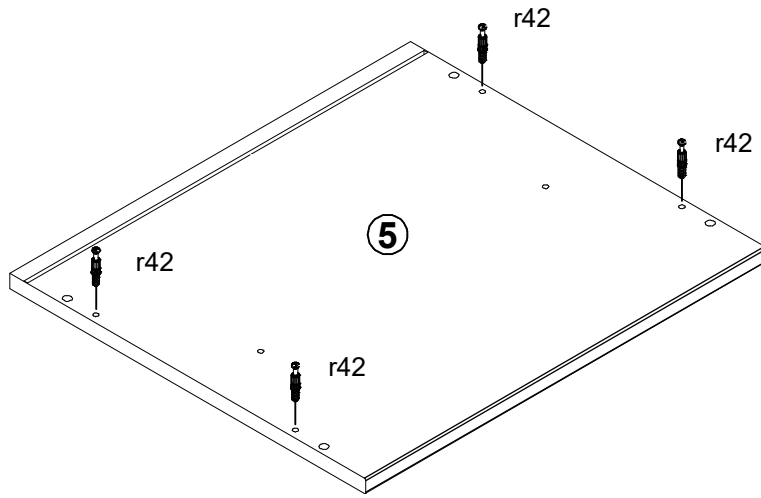

4 ▶

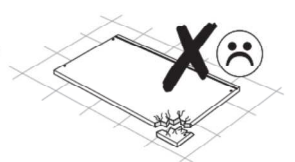
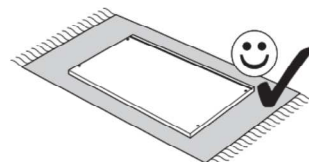
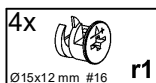
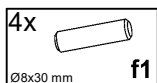
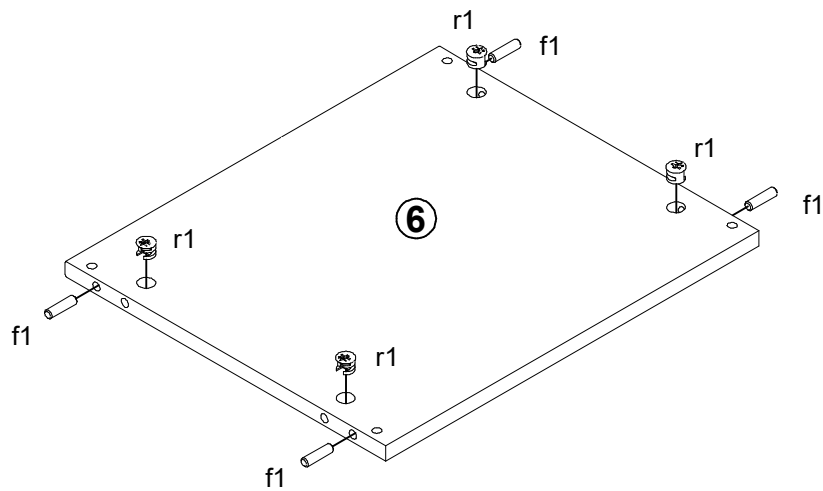



5 ▶

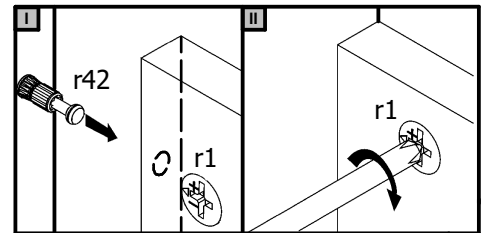
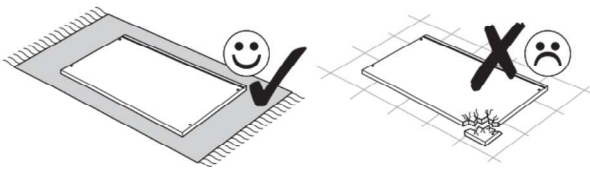
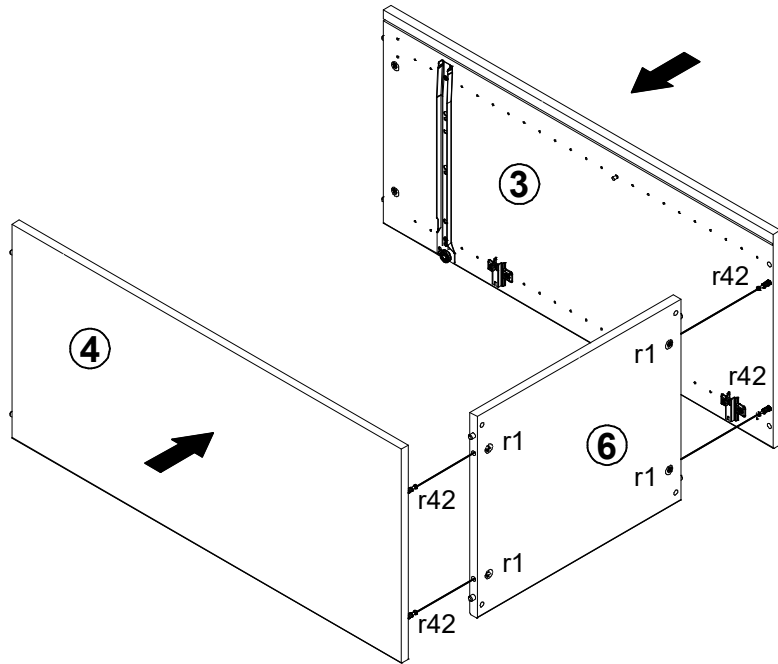

6 ▶

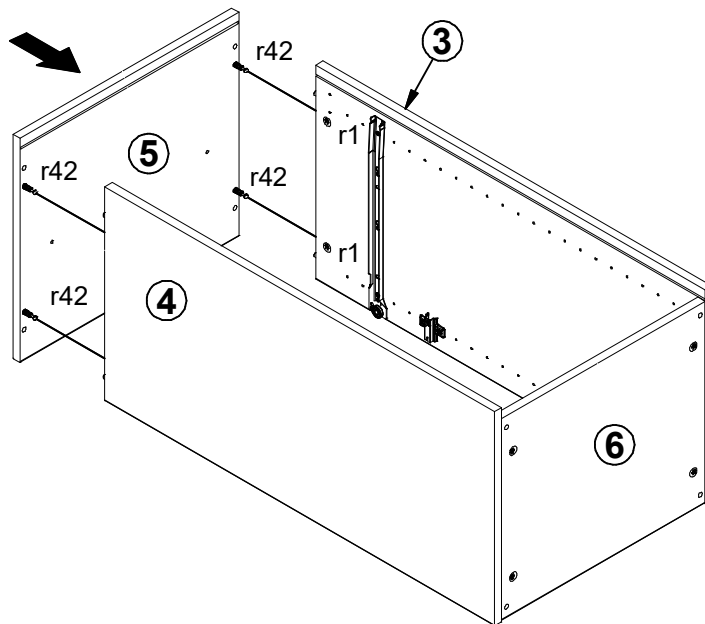



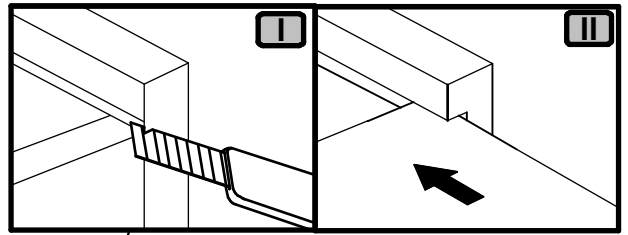

7 ▶

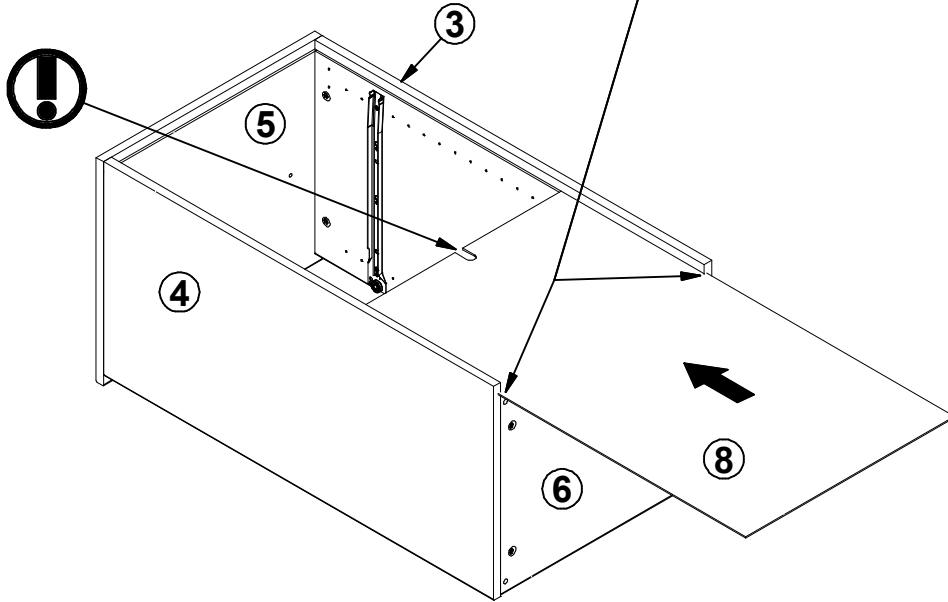

8 ▶

⚠  
A=B

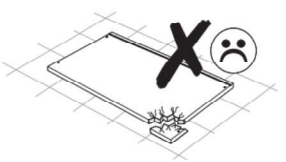
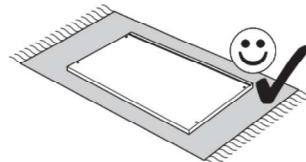
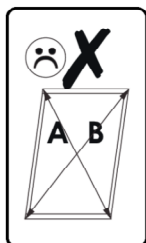
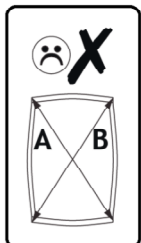
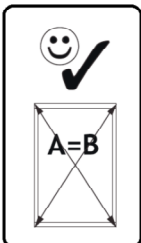
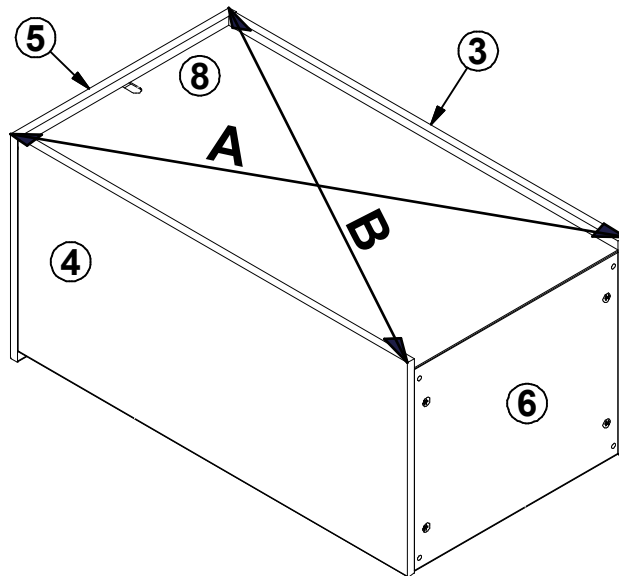

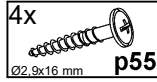
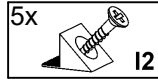

# 9

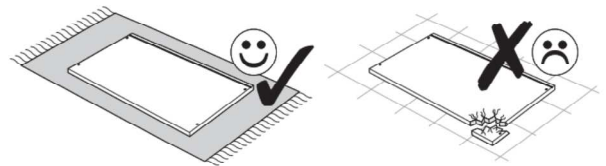
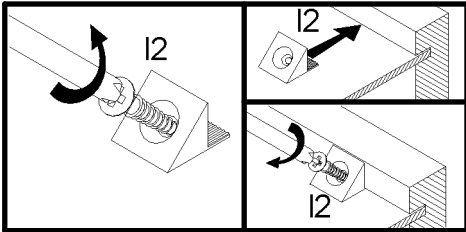
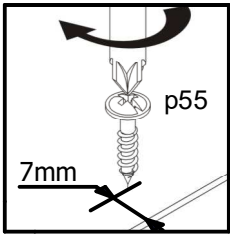
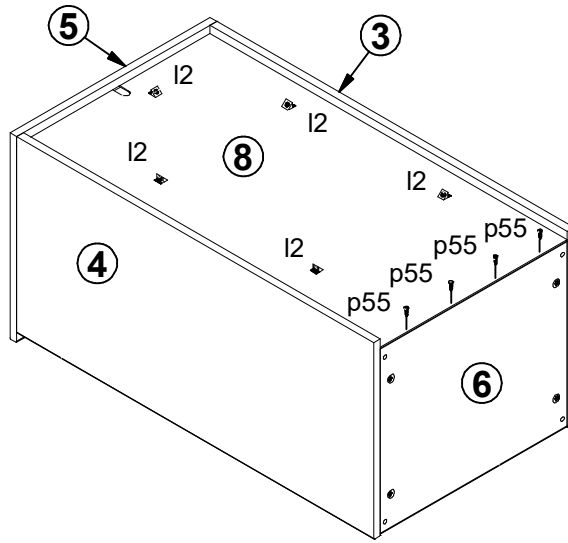

# 10

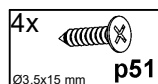
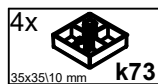
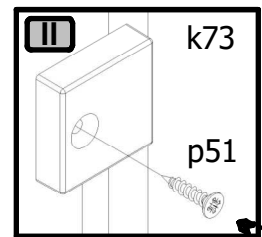
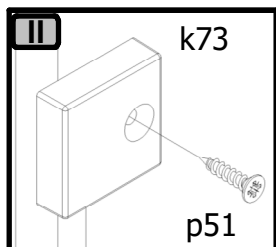
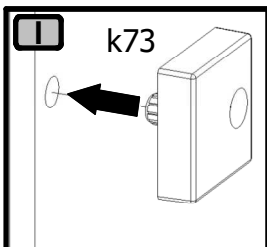
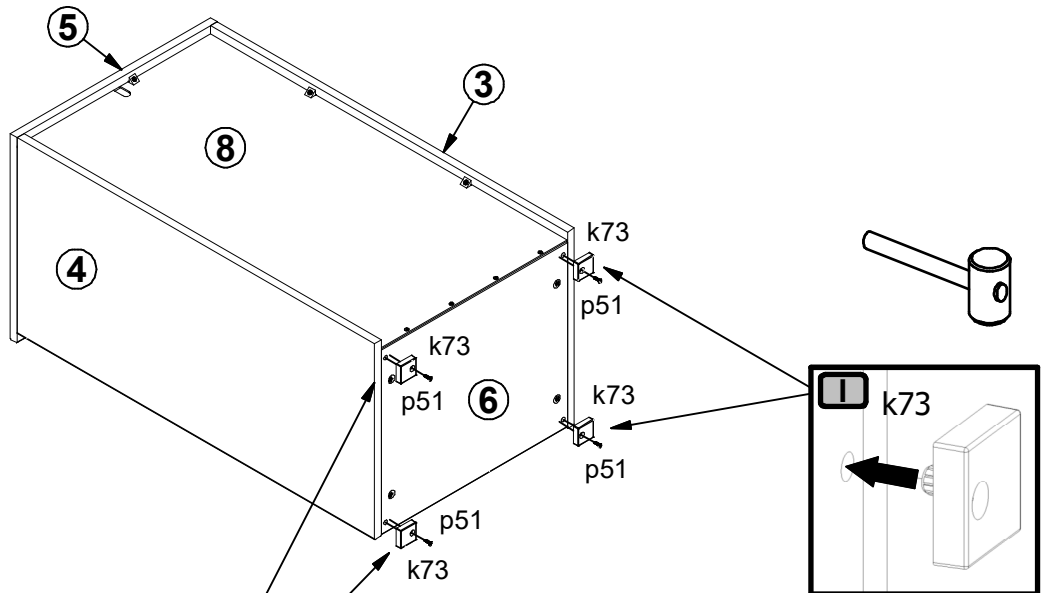

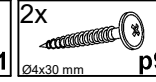
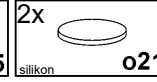
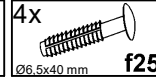
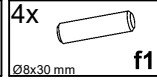
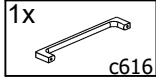

# 11

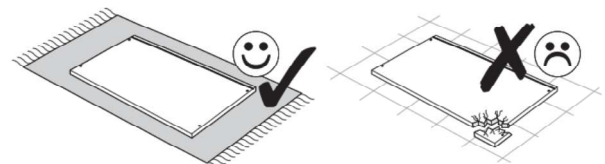
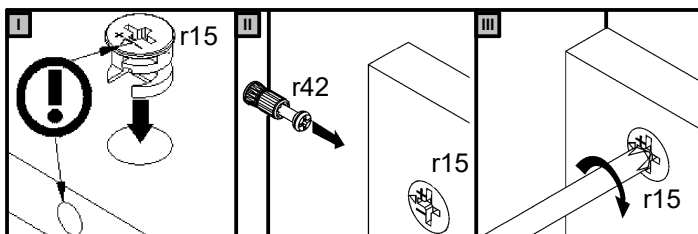
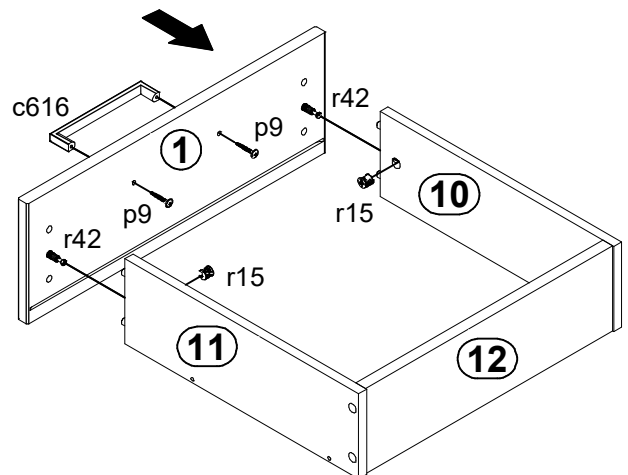
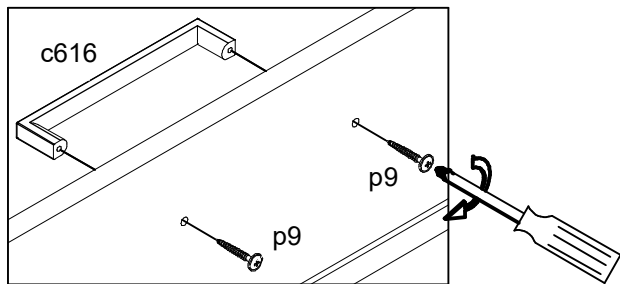
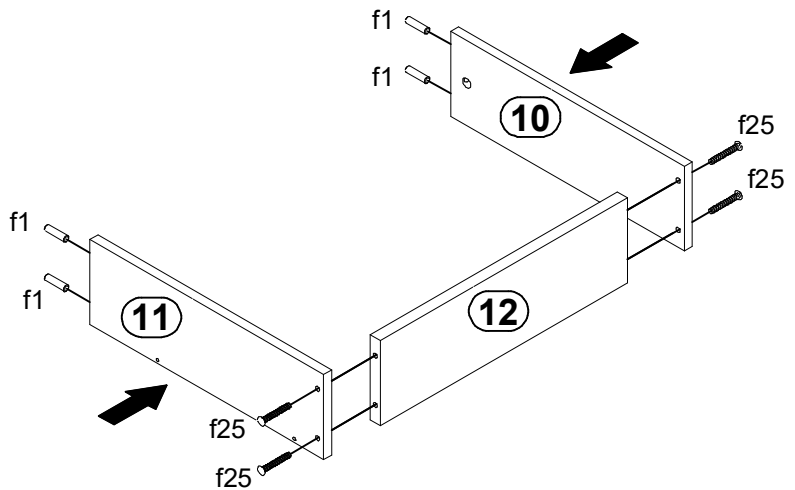
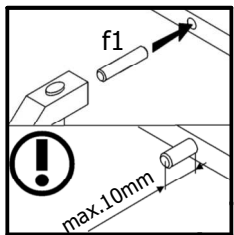
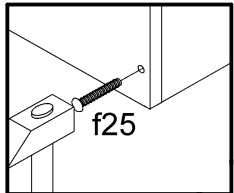
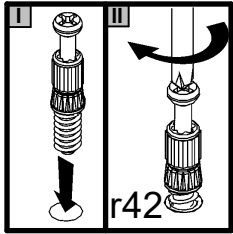
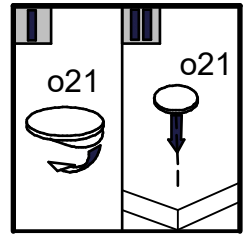
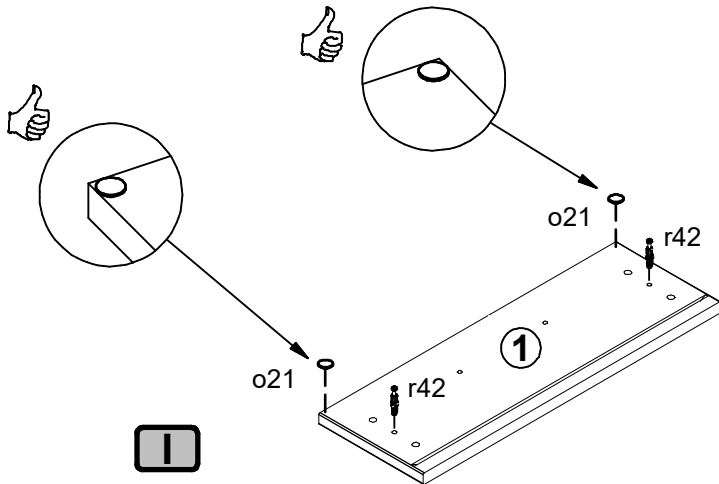

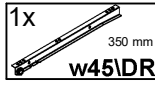
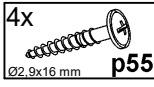
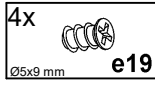

# 12

I

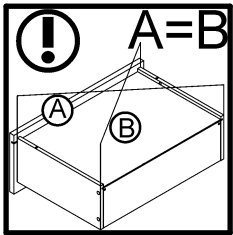
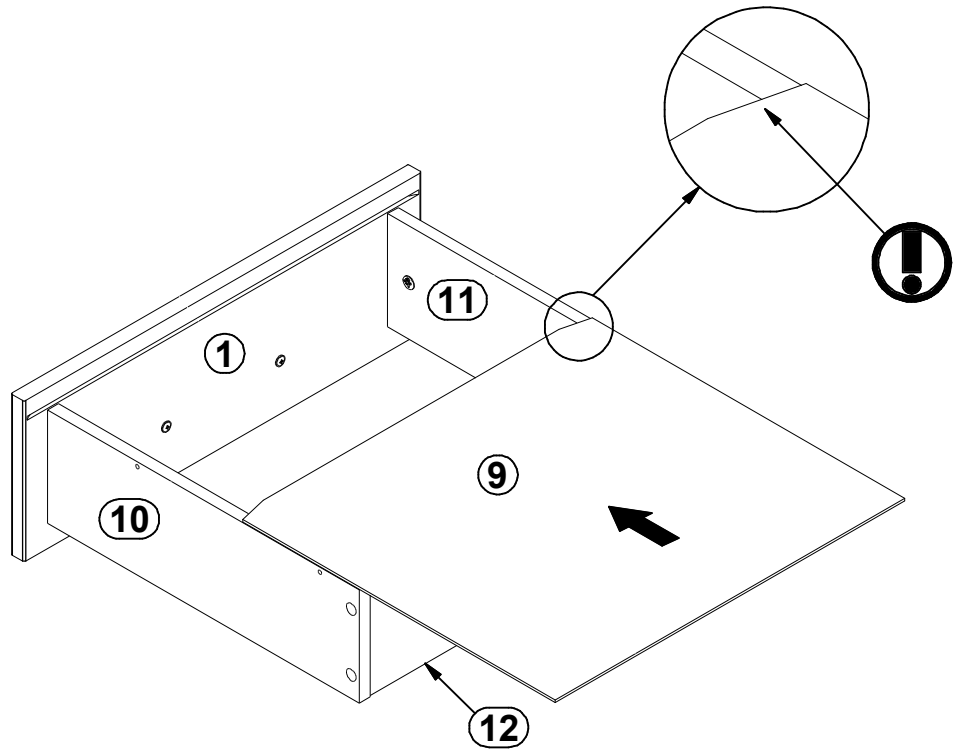

II

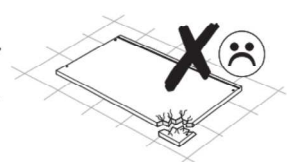
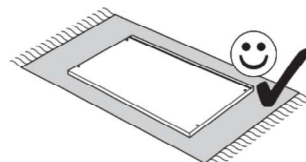
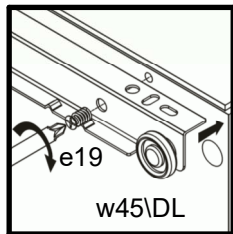
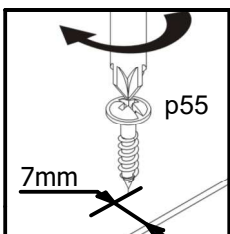
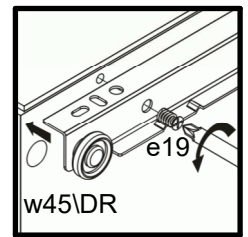
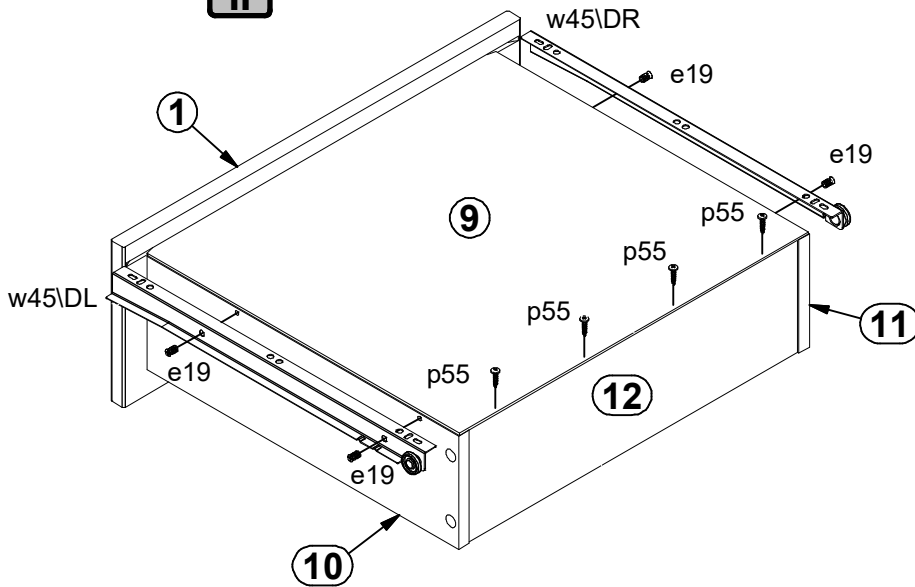

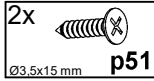
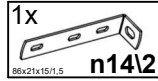

13 ▶

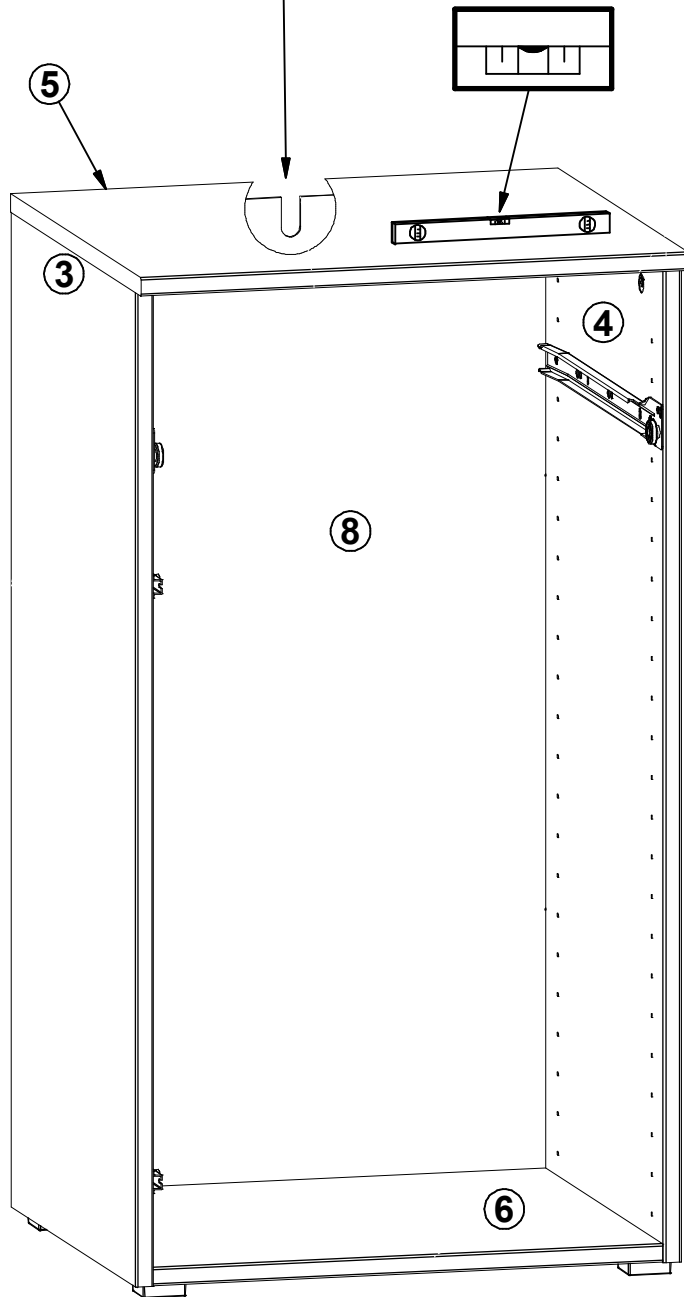
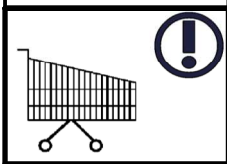
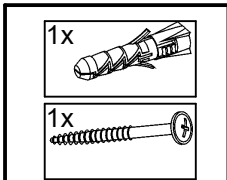
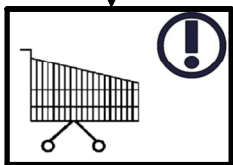
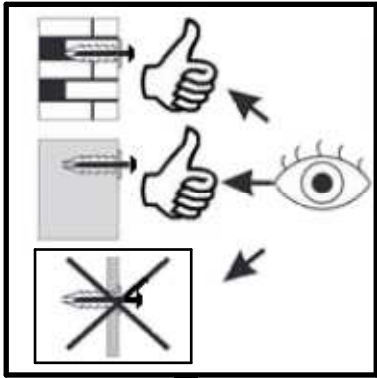
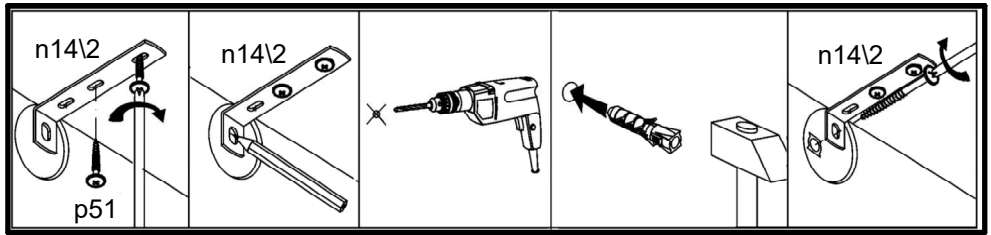



14

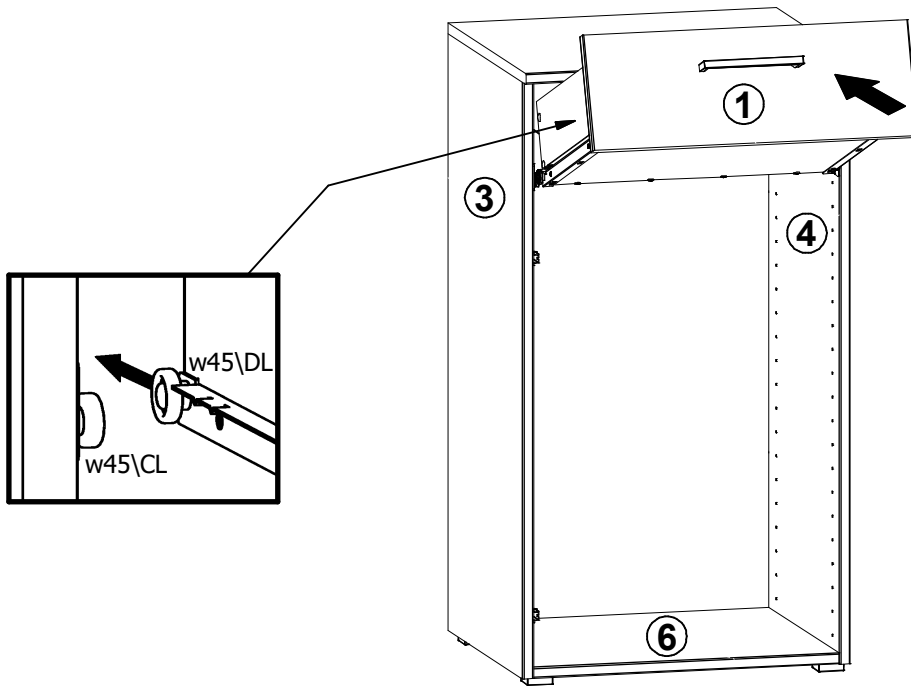

15

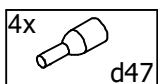
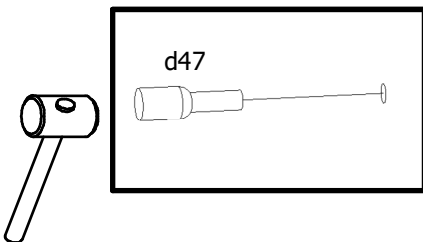
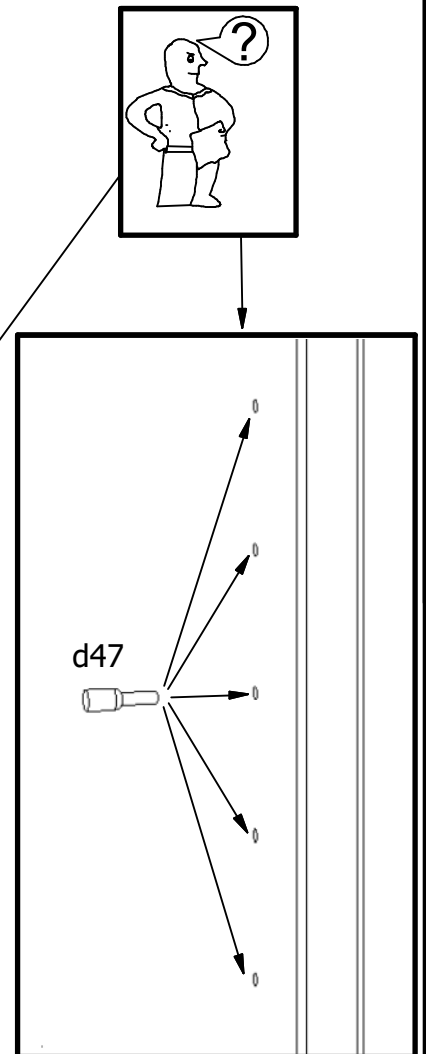
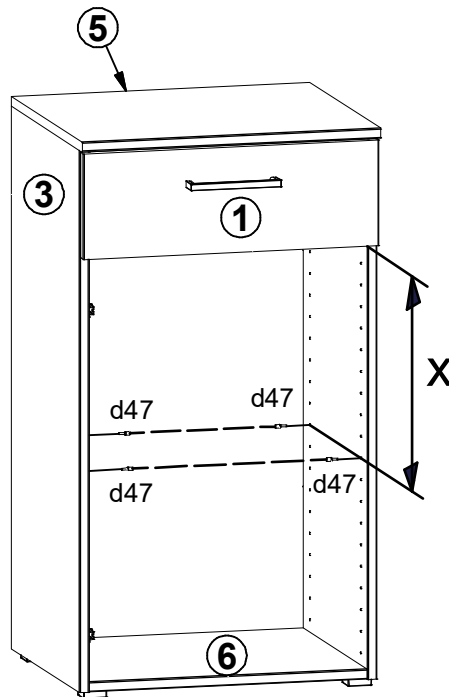

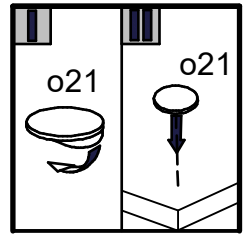
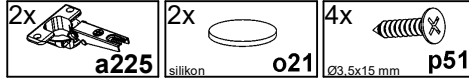

# 16

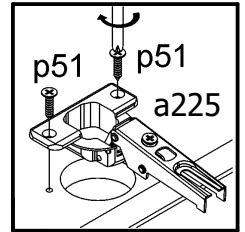
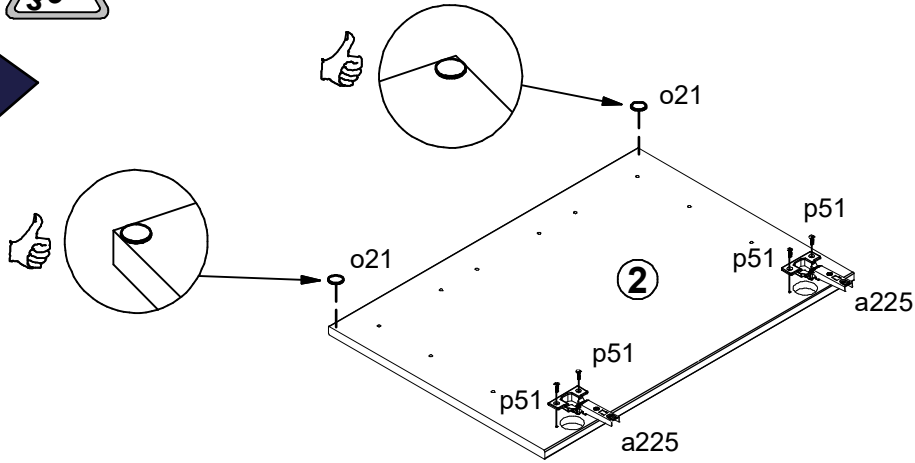

# 17

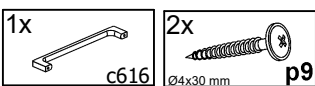
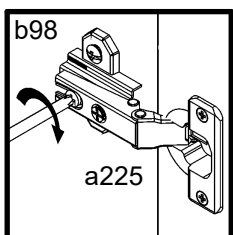
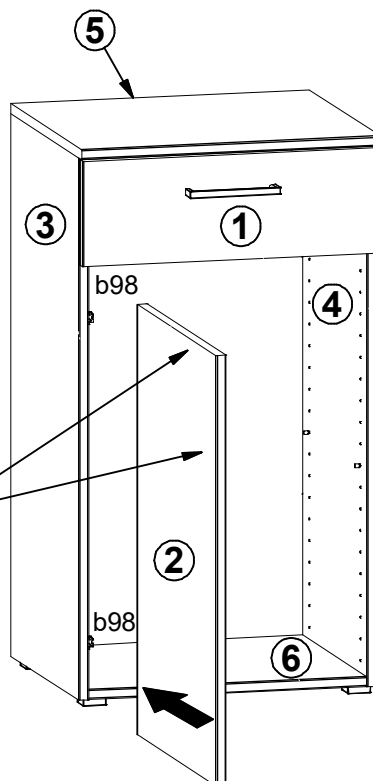
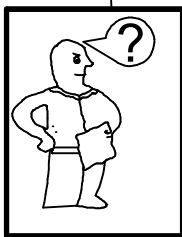
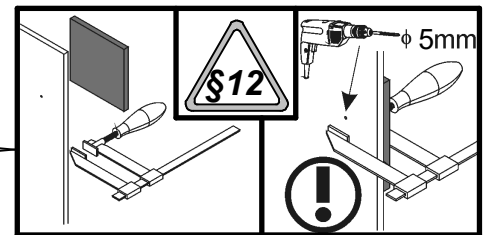
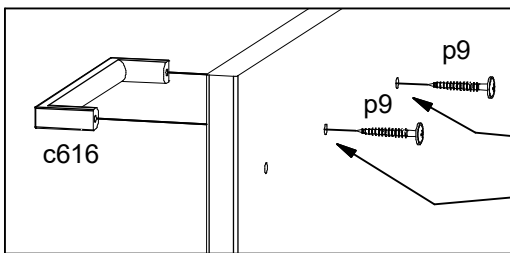
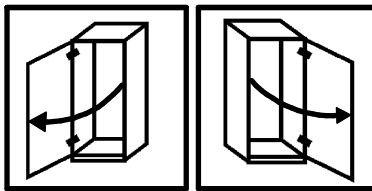



18 ▶

