

13450197...  
 242702.../28  
 242701.../28  
 5107117  
 5107434  
 5107435  
 5107436

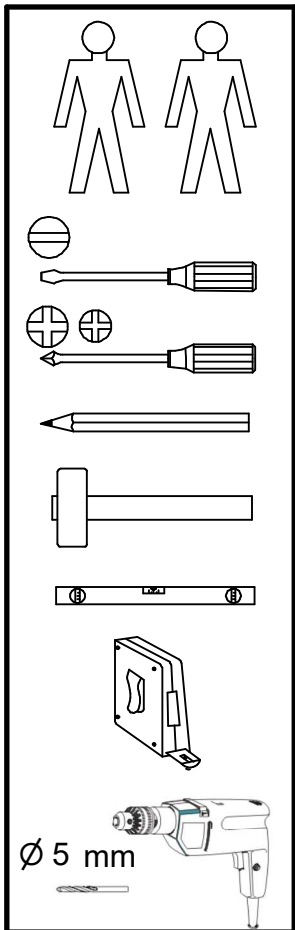

∅ 5 mm

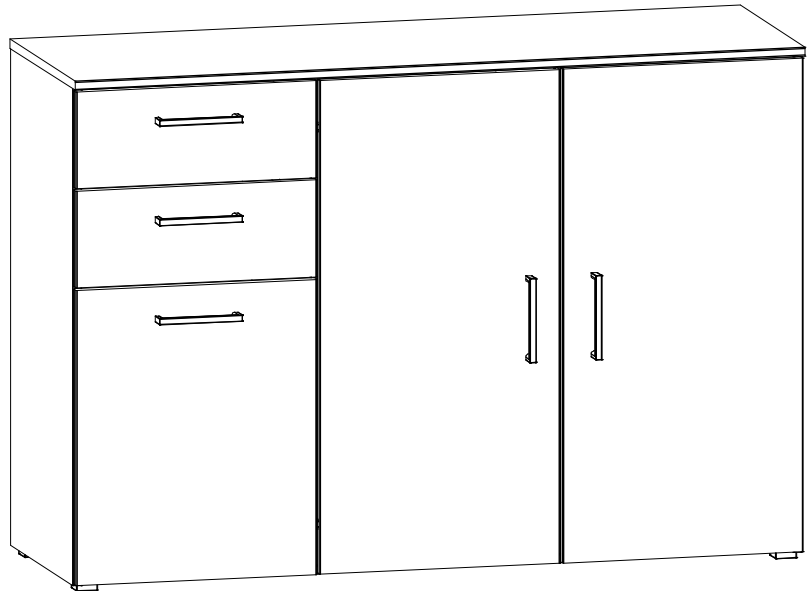

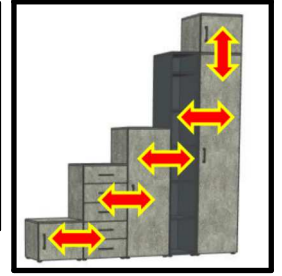
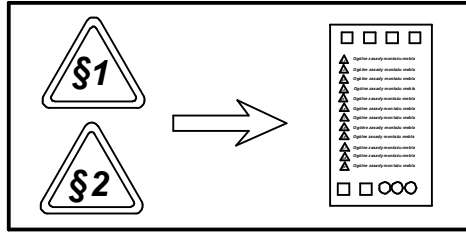
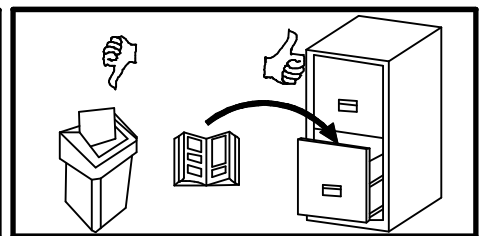
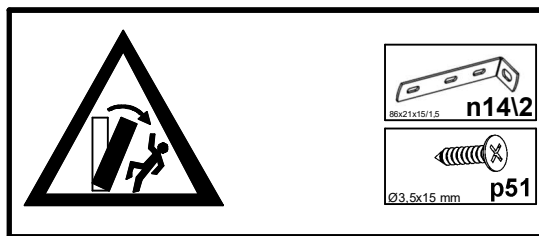
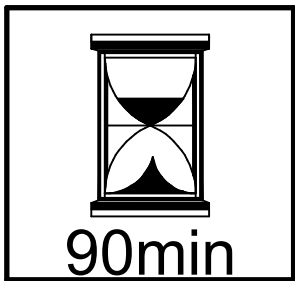
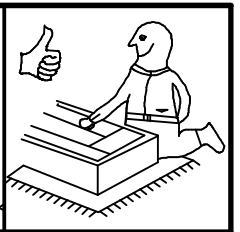
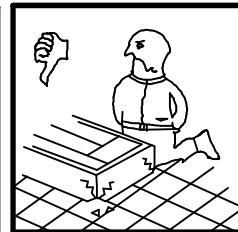
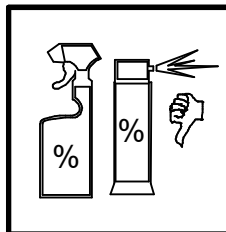
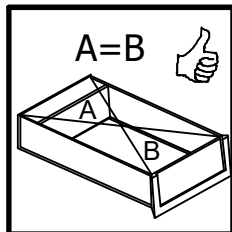
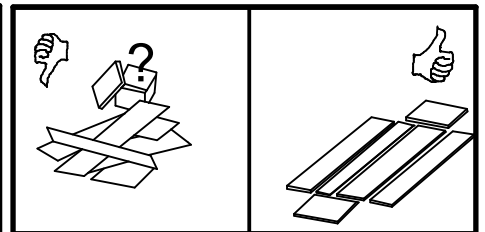
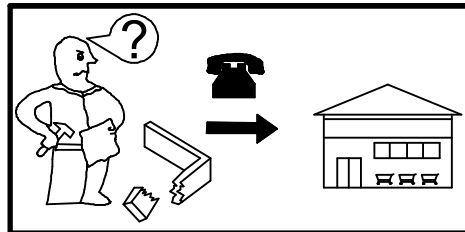
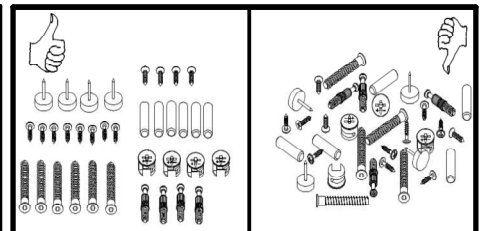
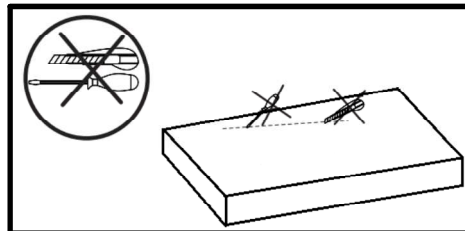

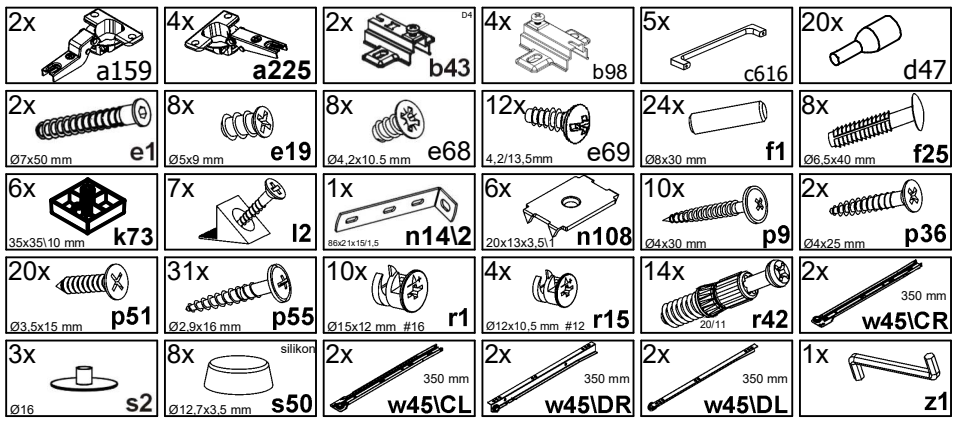
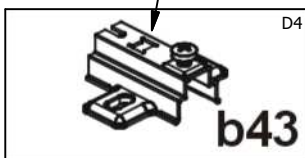
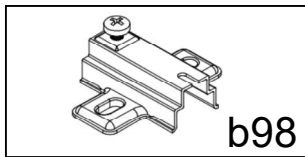

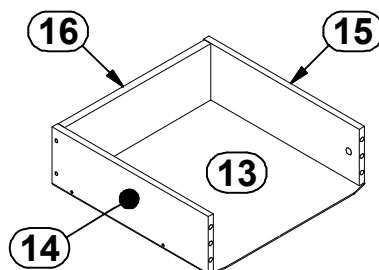
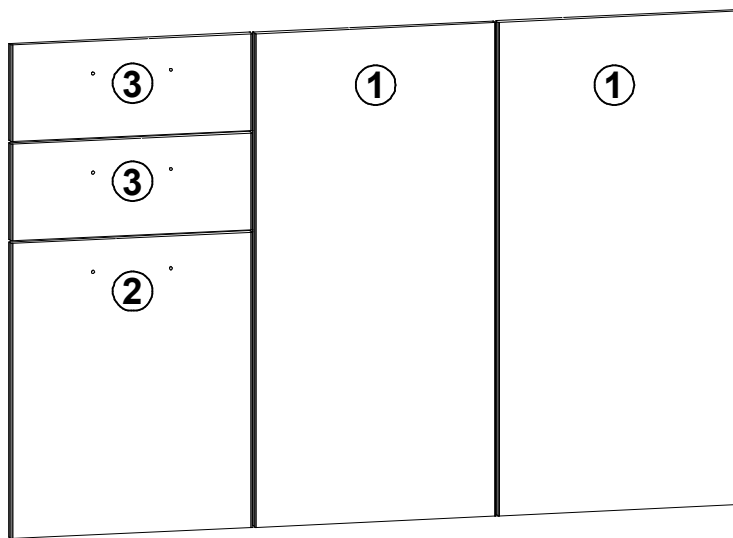
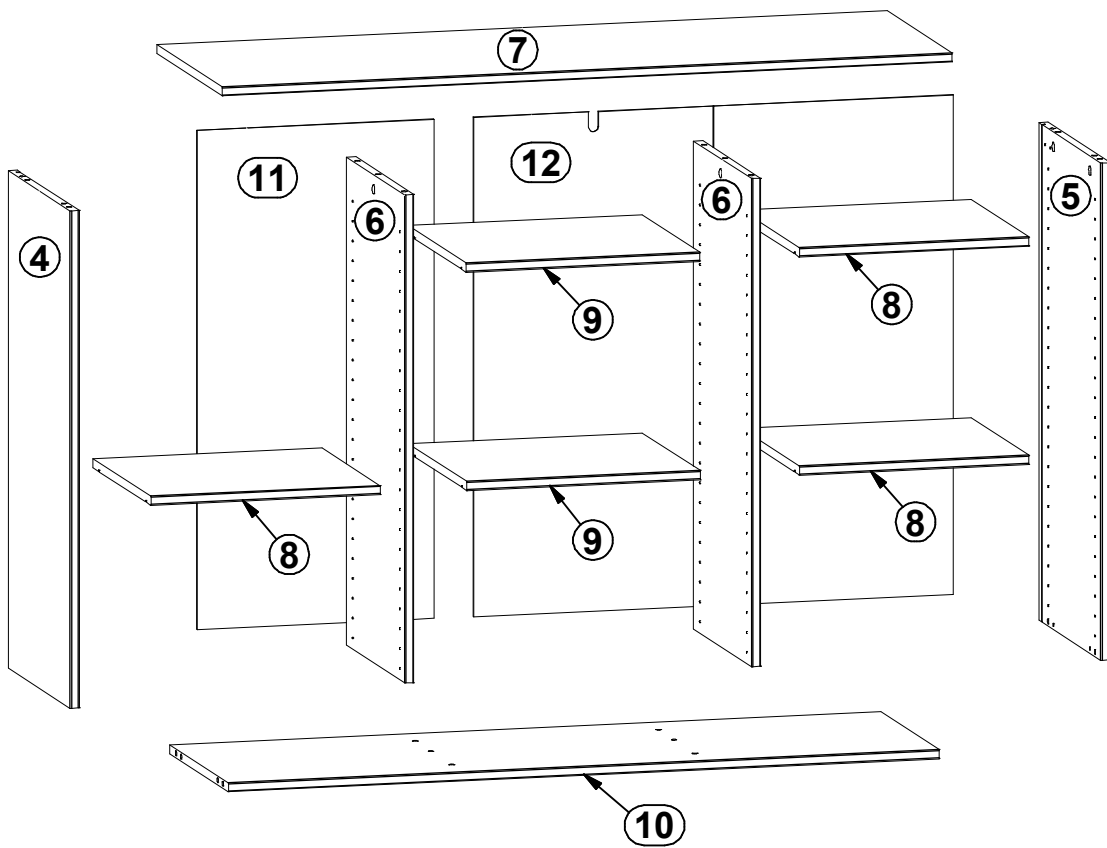

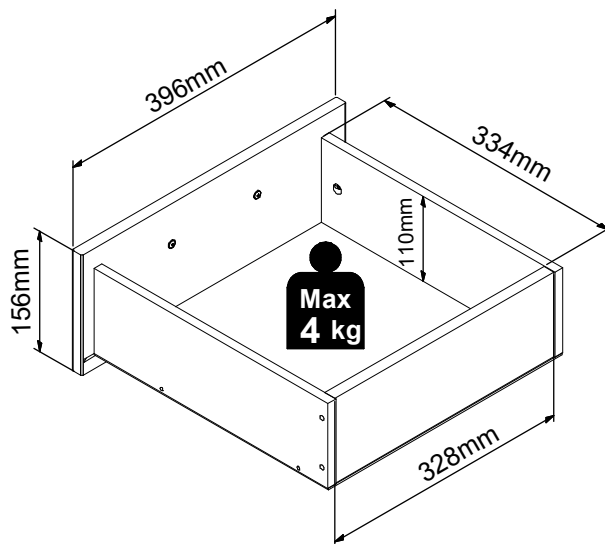
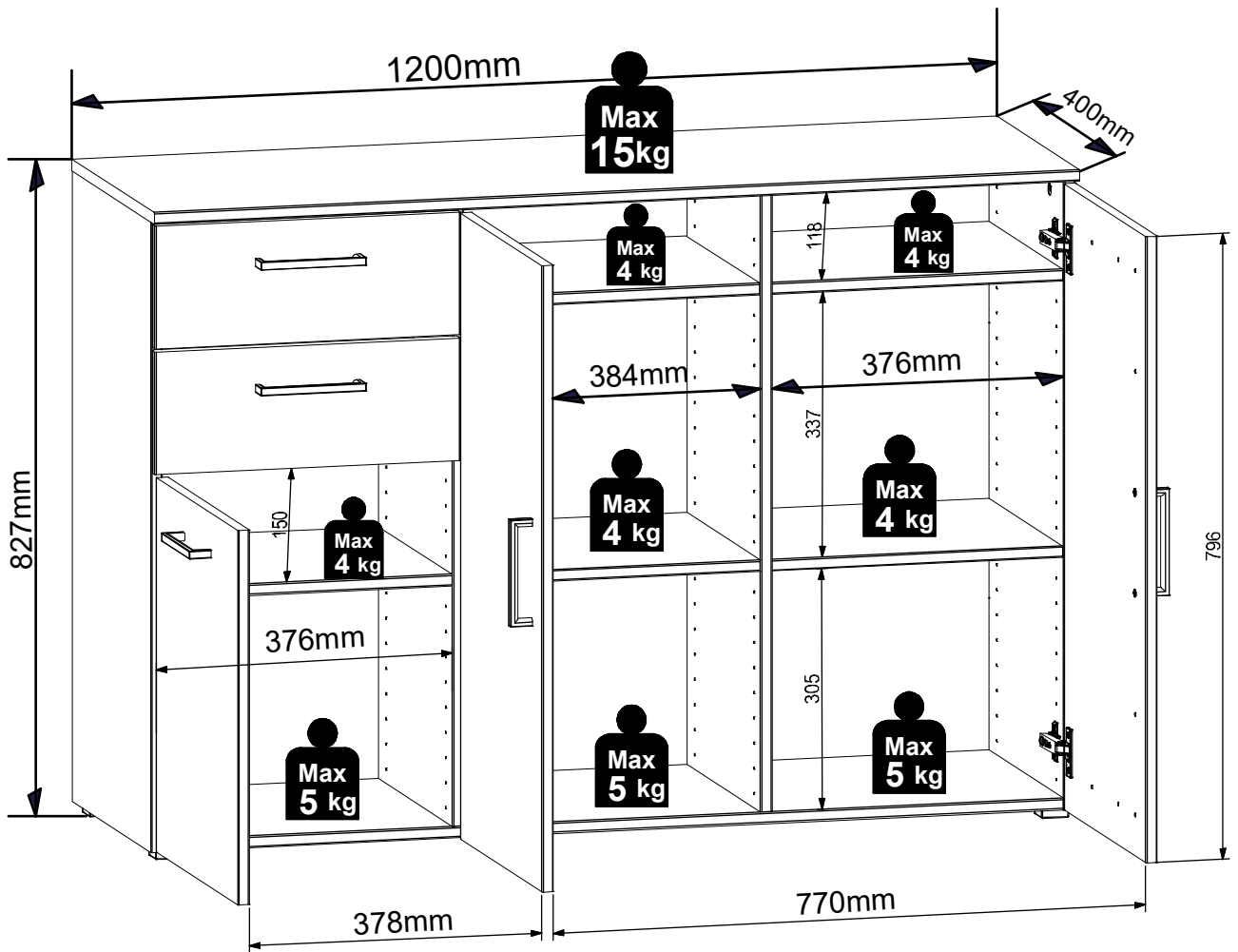
A	B1	B2	C1	C2	C3	D
1	S588-0008	-.4	796	396	15	2/2
2	S588-0009	-.5	476	396	15	2/2
3	S588-0010	-.7	156	396	15	2/2
4	S588-1003	-.8	802	382	15	1/2
5	S588-1004	-.7	802	382	15	1/2
6	S588-1005	-.3	787	358	15	1/2
7	S588-2005	-.3	1200	400	15	2/2
8	S588-3008	-.2	377	356	15	2/2
9	S588-3009	-.1	384	356	15	1/2
10	S588-3010	-.1	1169	360	15	2/2
11	S588-9005	-.1	805	389	2,5	2/2
12	S588-9304	-.2	805	789	2,5	2/2
13	WSP-9704	B.53	350	358	2,5	2/2
14	WSR2-5005	-.5	350	110	12	1/2
15	WSR2-5006	-.5	350	110	12	1/2
16	ZS7-5132	-.14	328	110	15	1/2









2x  b98	4x  e68 Ø4,2x10,5 mm	4x  e69 4,2/13,5mm	2x  f1 Ø8x30 mm	2x  r1 Ø15x12 mm #16	2x  r42	2x  w45\CL 350 mm
--	--	--	---	--	--	---

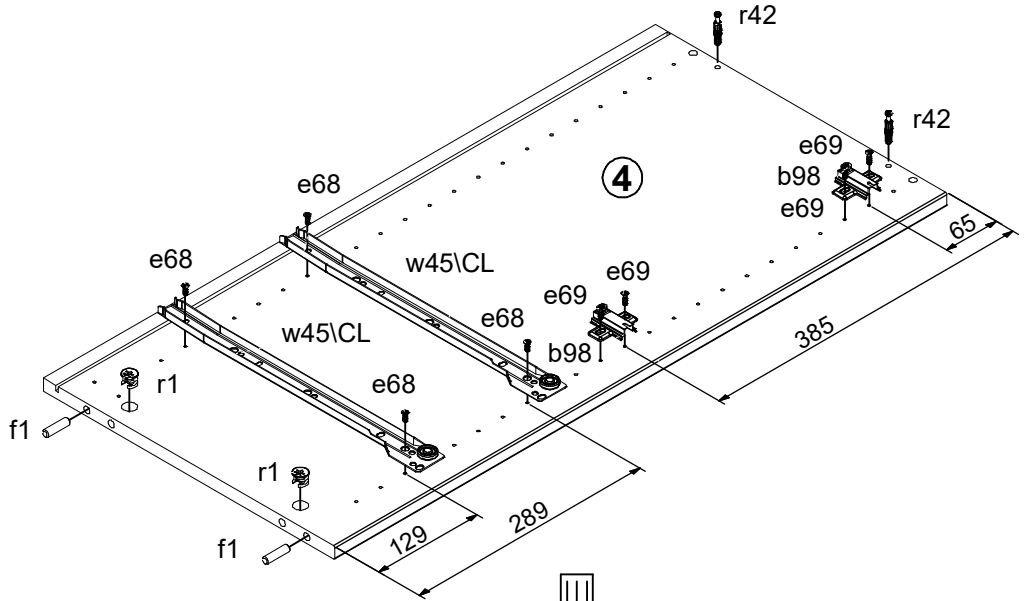
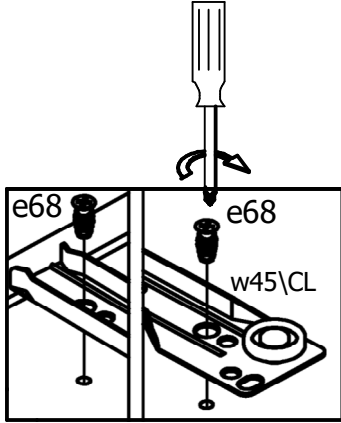



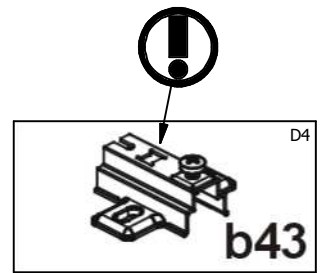
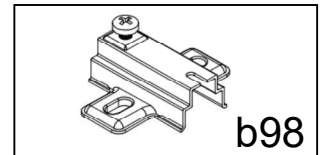
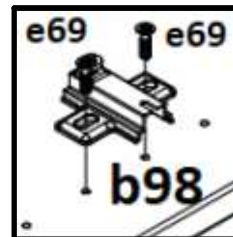
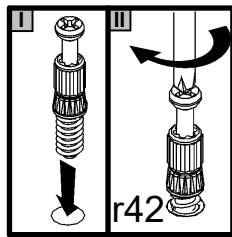
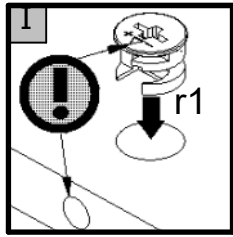
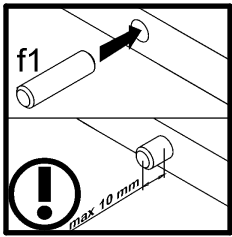

1 ▶

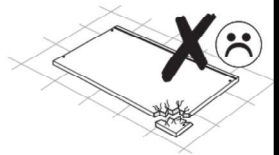
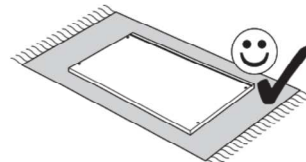
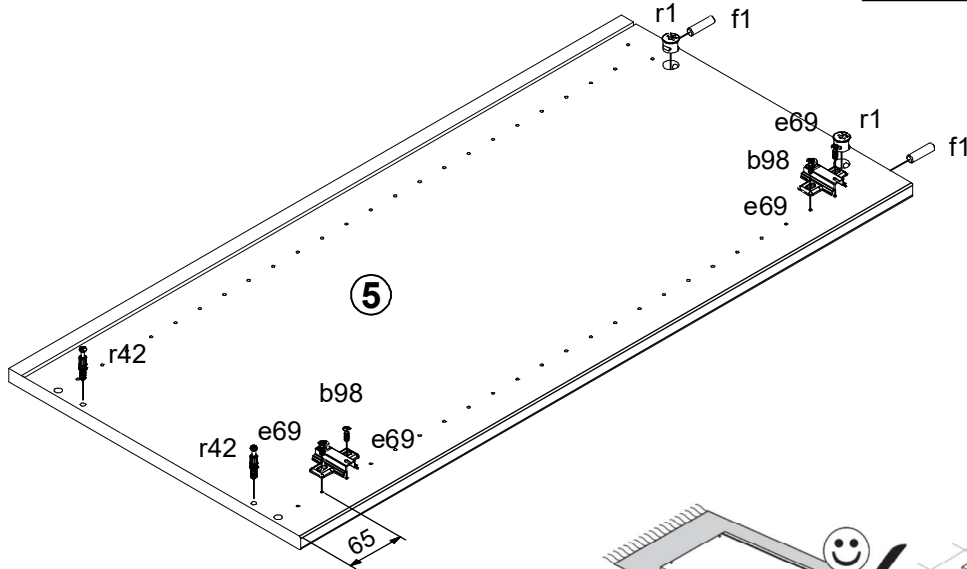

2 ▶

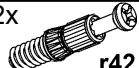

2x  b98	4x  e69 4,2/13,5mm	2x  f1 Ø8x30 mm	2x  r1 Ø15x12 mm #16	2x  r42
--	--	---	--	--

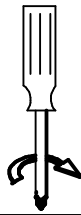
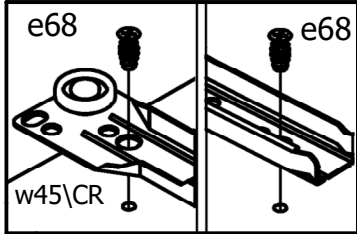
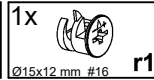
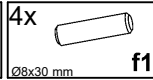
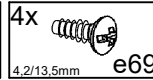
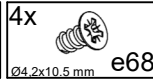
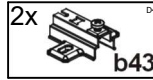

3

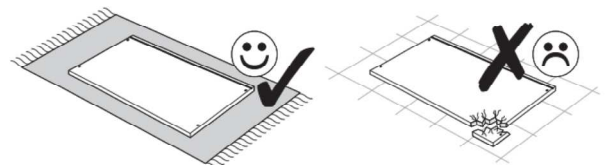
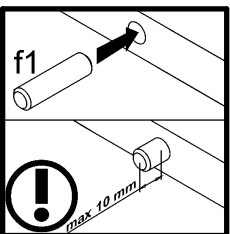
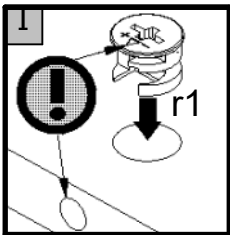
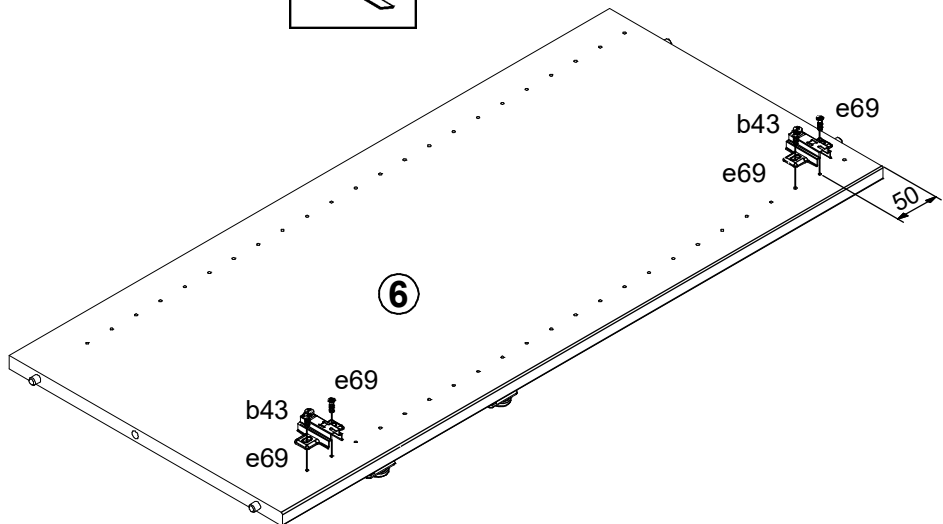
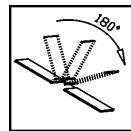
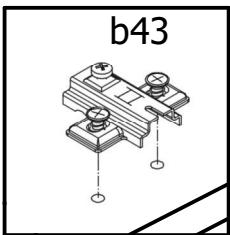
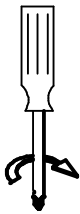
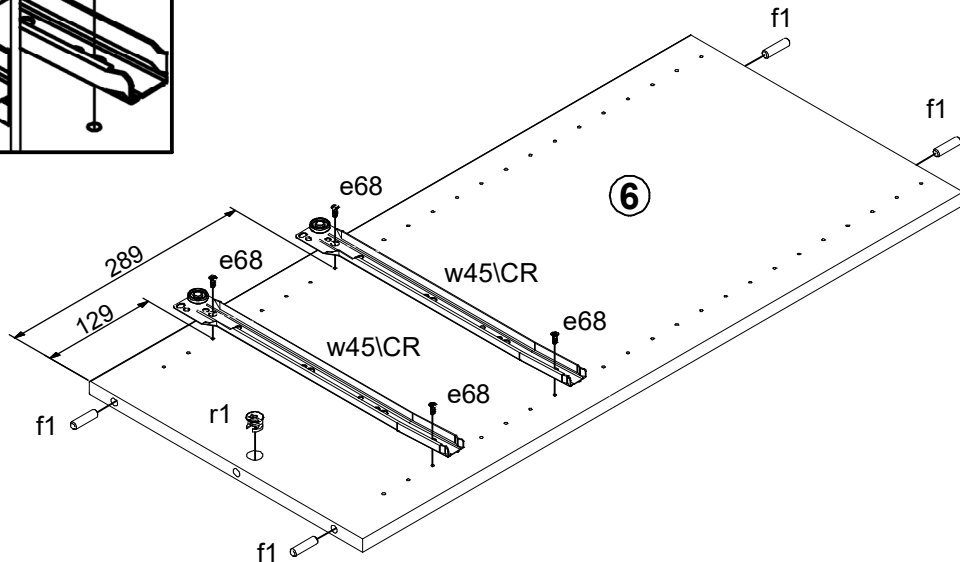

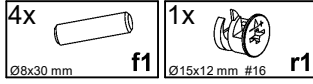

4 ▶

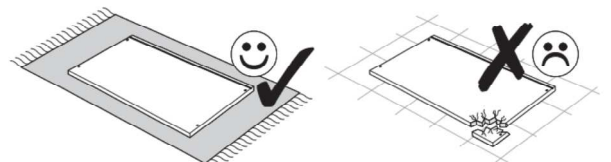
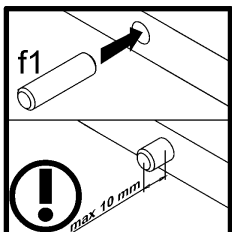
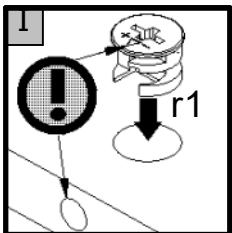
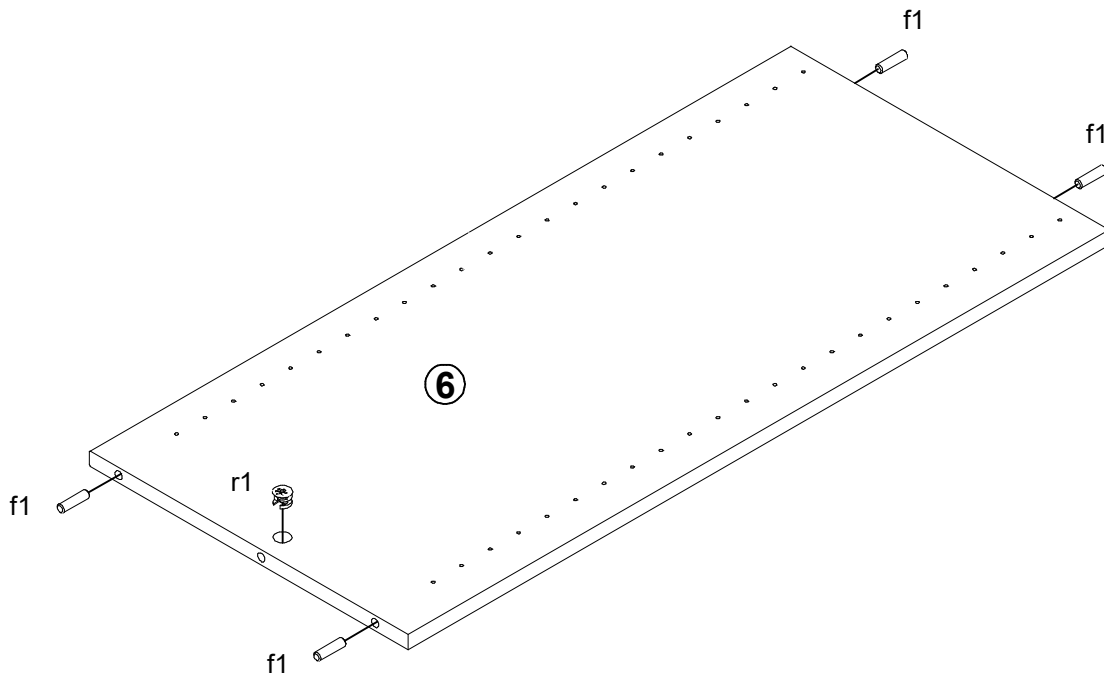

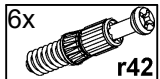

5 ▶

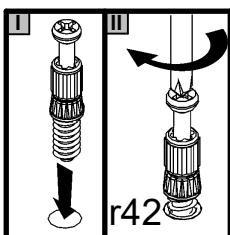
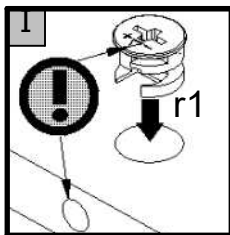
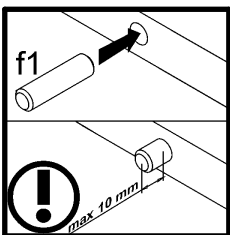
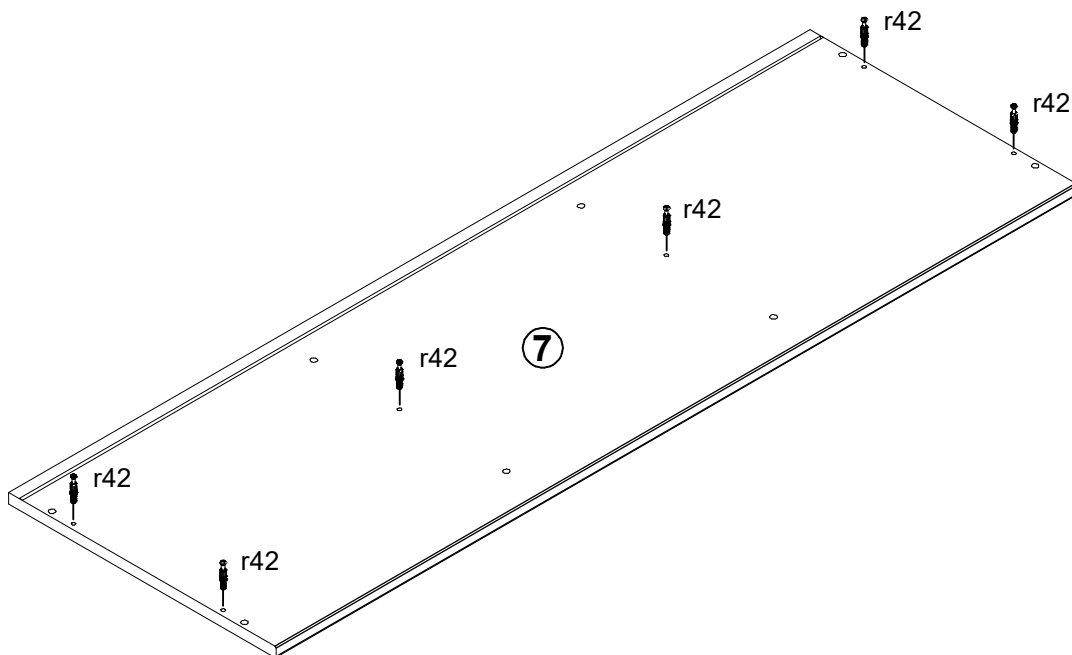

6 ▶

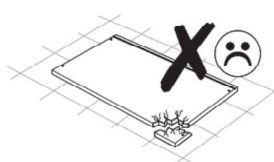
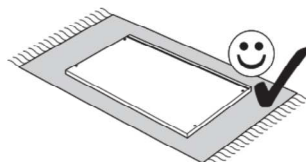
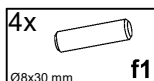
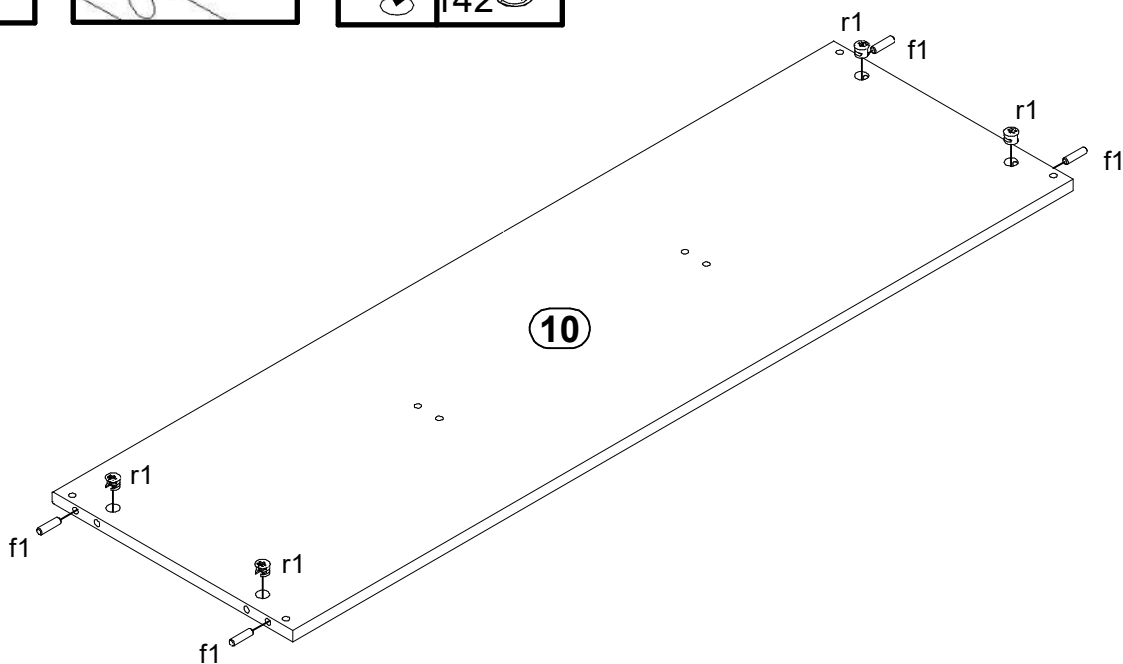



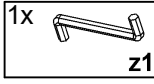
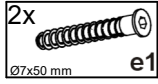

7 ▶

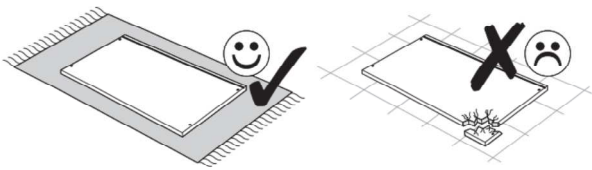
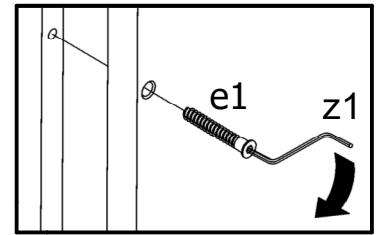
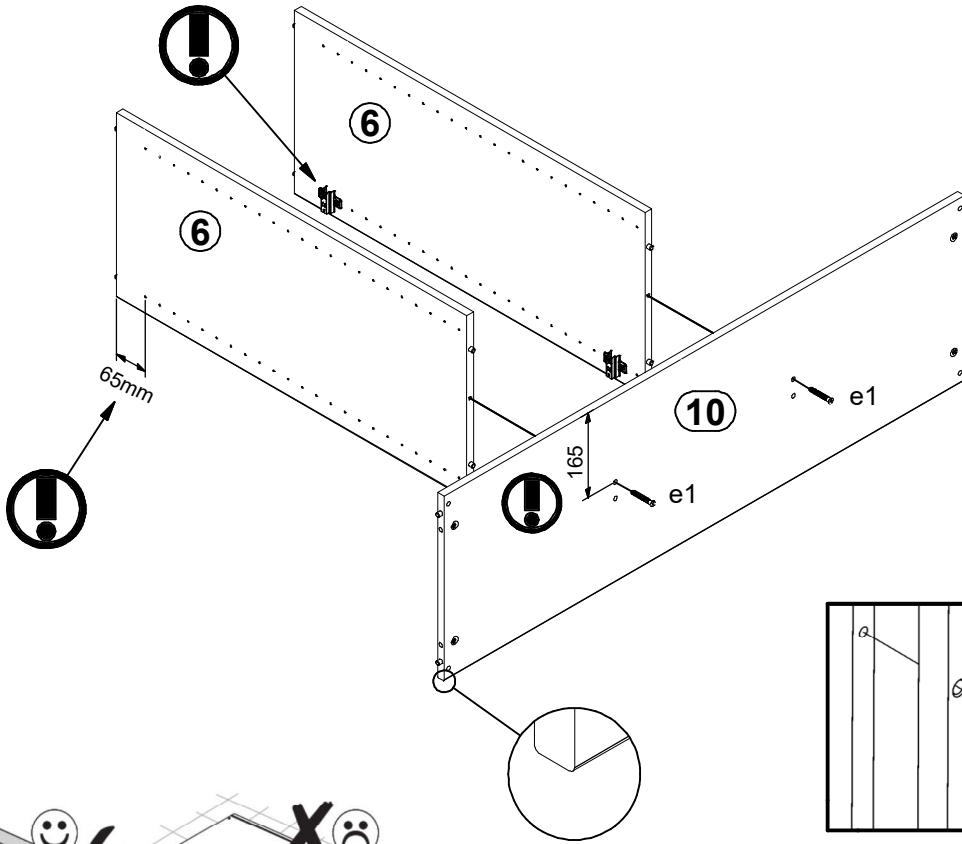

8 ▶

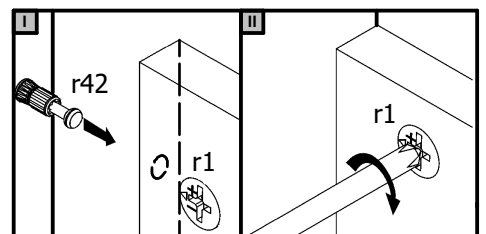
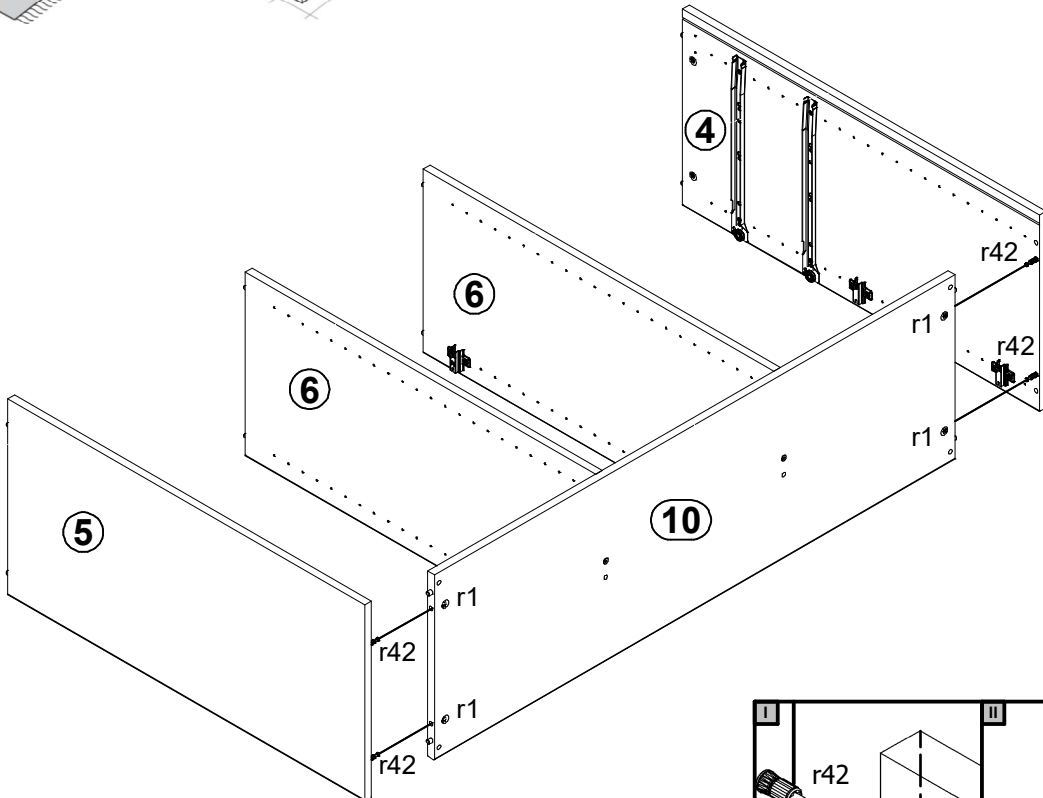

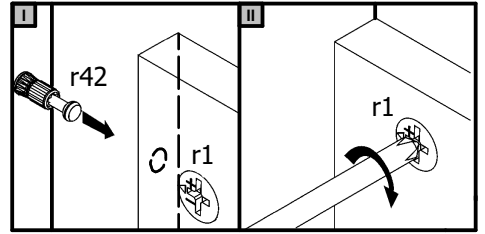

9

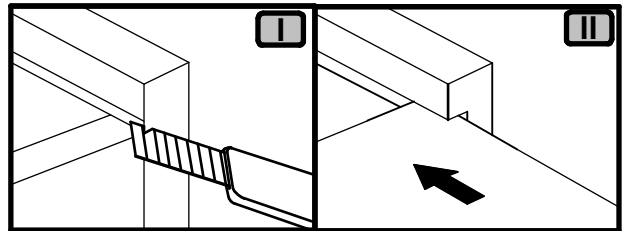
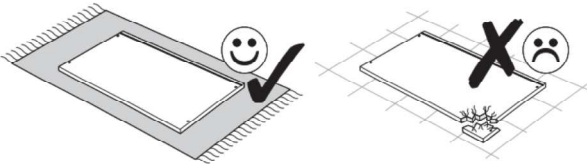
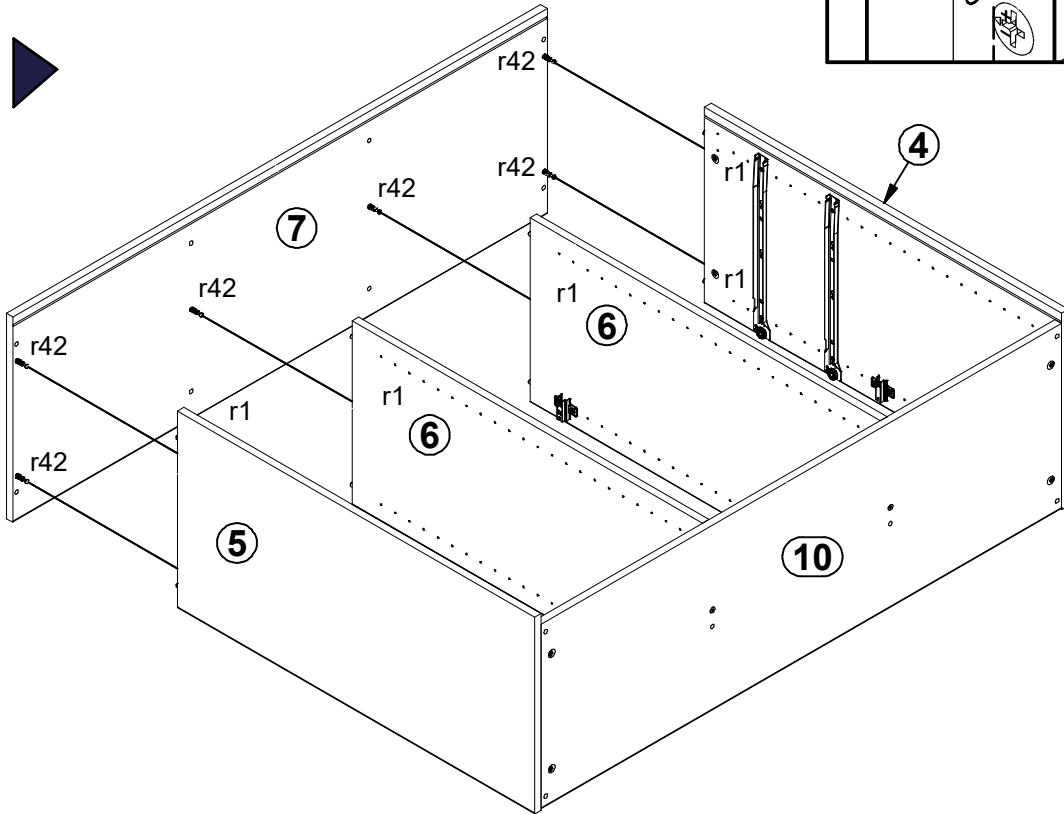

10

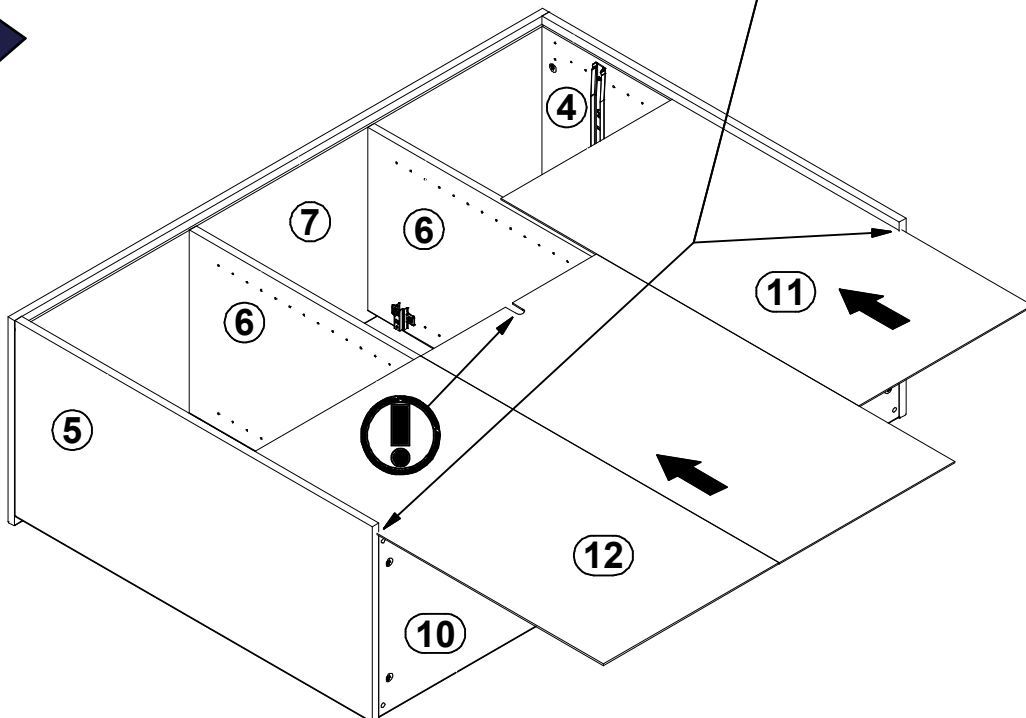

**11** ▶

7x l2, 6x n108, 23x p55

! 384mm 7mm

☺ ✓ ☹ ✗ ☹ ✗

! ⚠

**12** ▶

6x k73, 6x p51

I k73, p51

II k73, p51

! ⚠

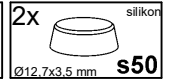
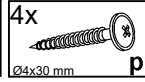
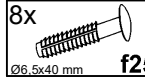
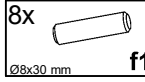
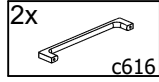

13 ▶

2x !

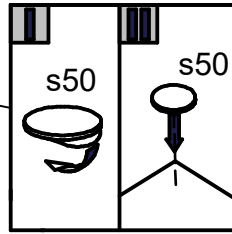
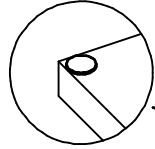
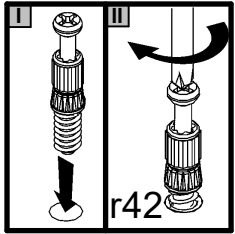

I

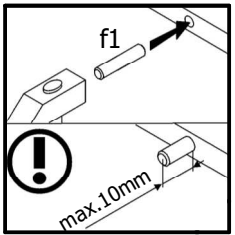
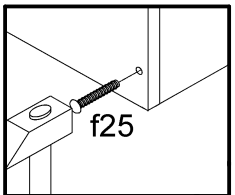
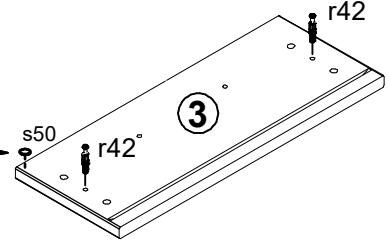

II

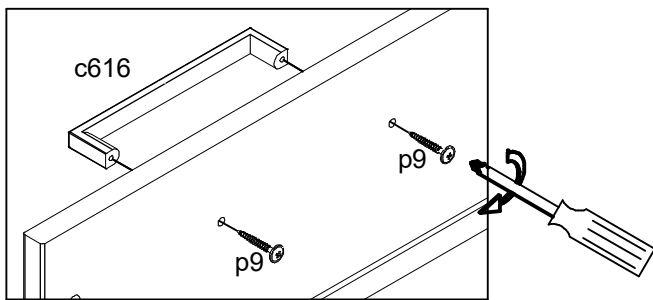
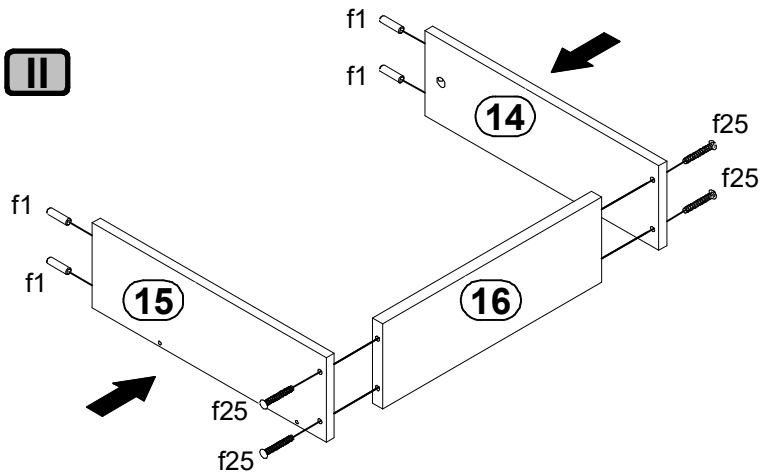

III

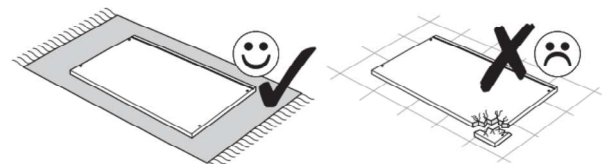
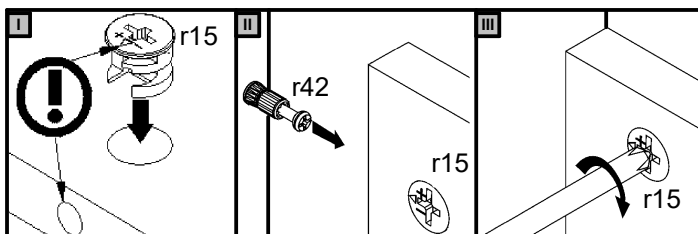
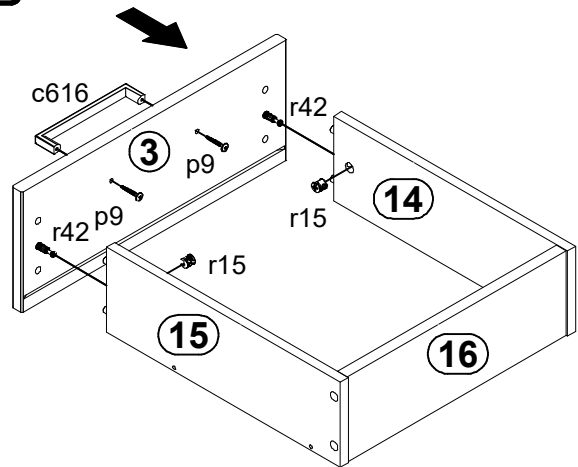

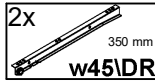
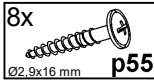
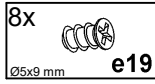

14 ▶

! 2x

I

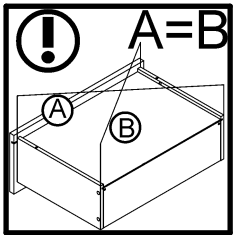
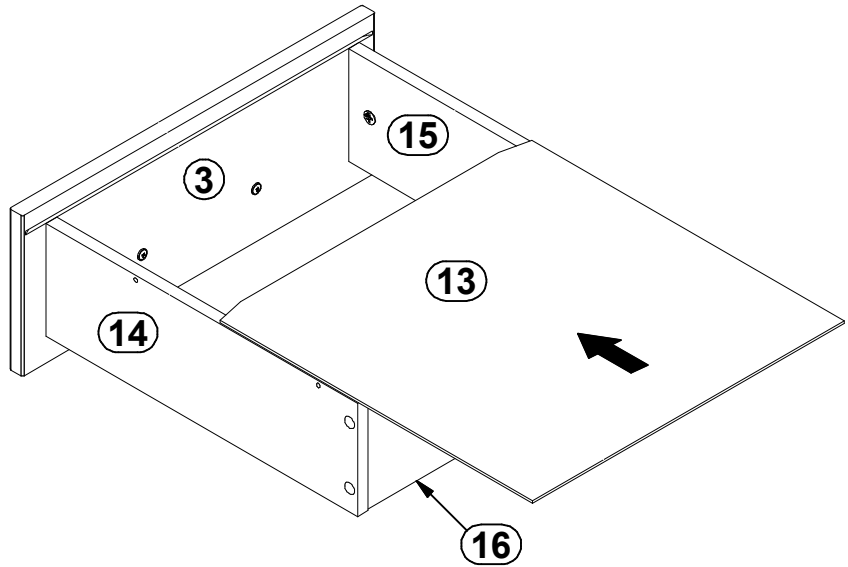

II

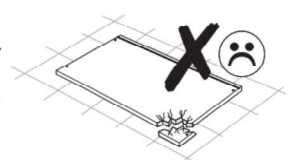
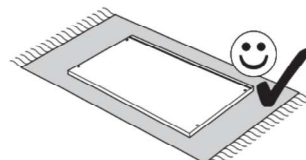
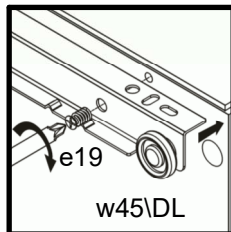
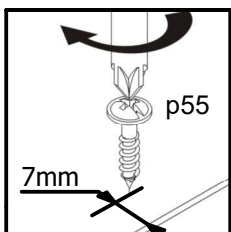
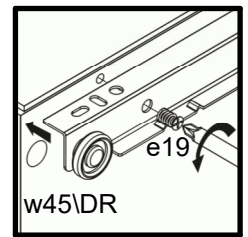
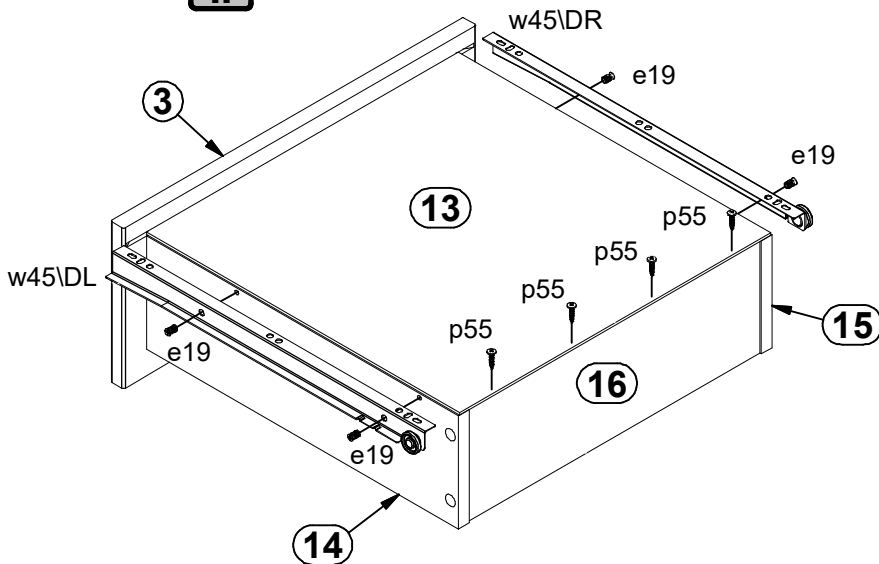

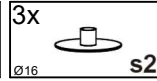
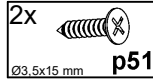
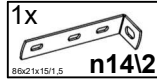

# 15

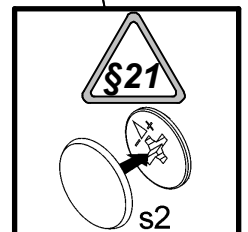
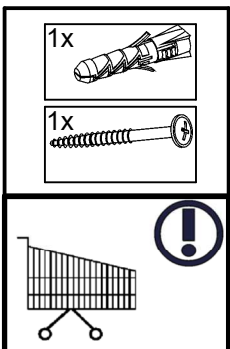
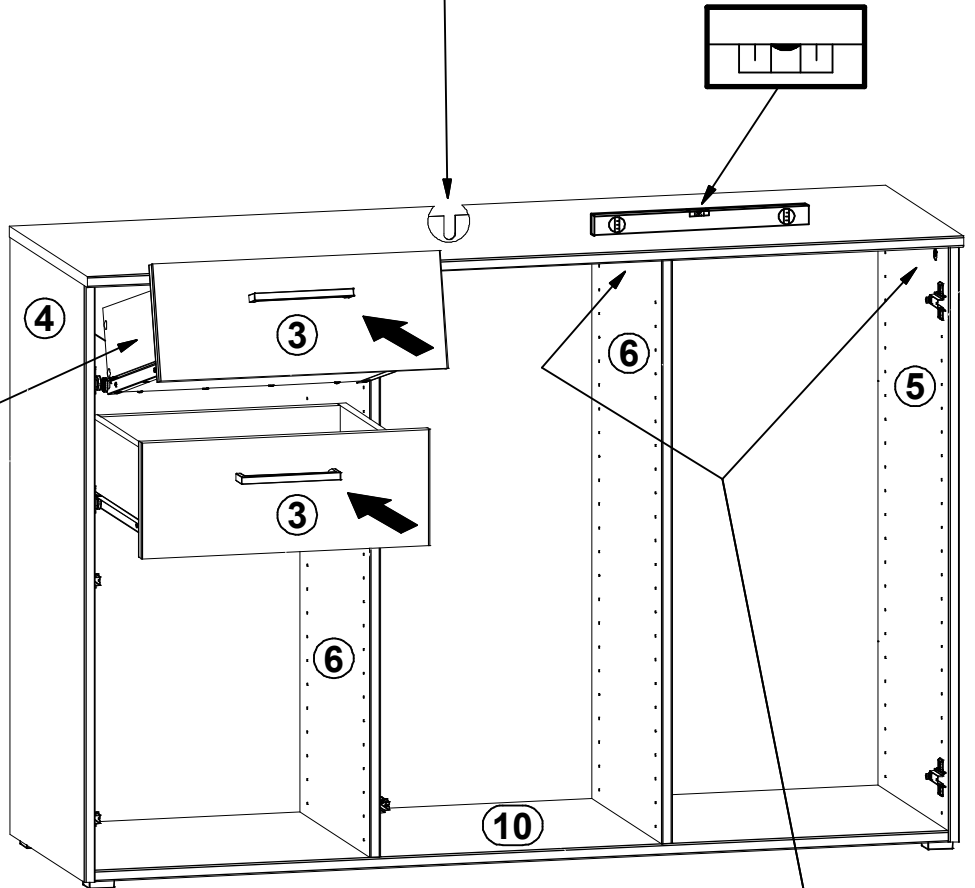
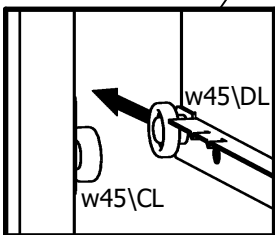
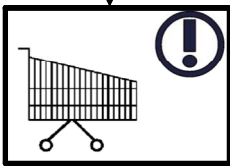
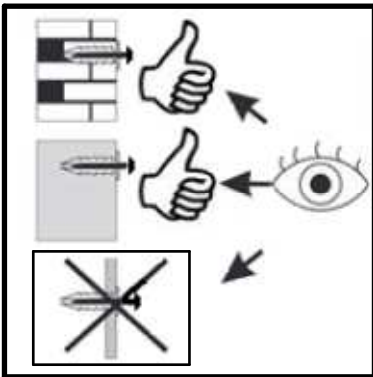
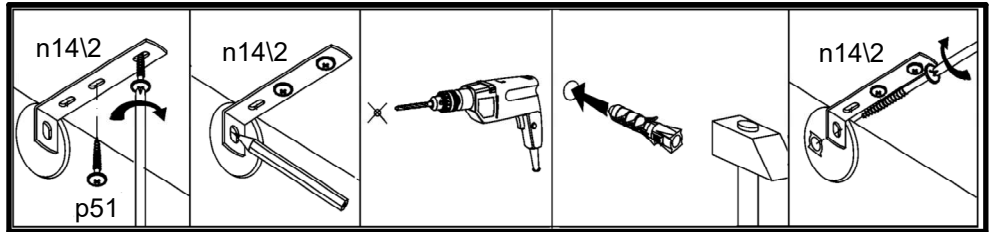

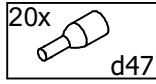

# 16 ▶

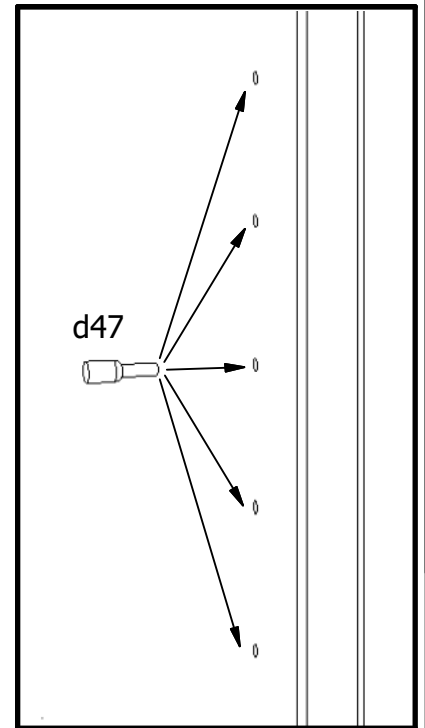
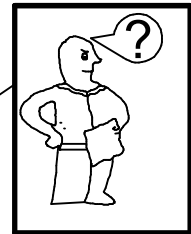
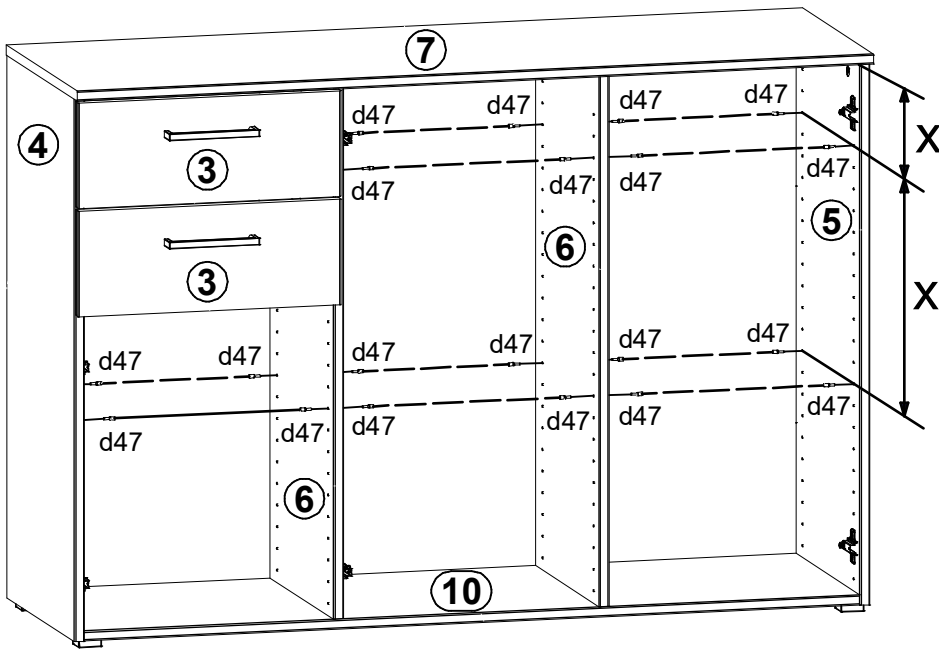
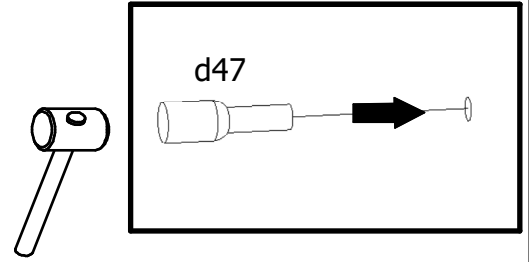

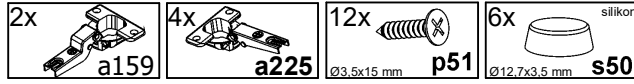

17

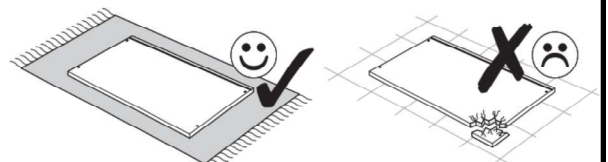
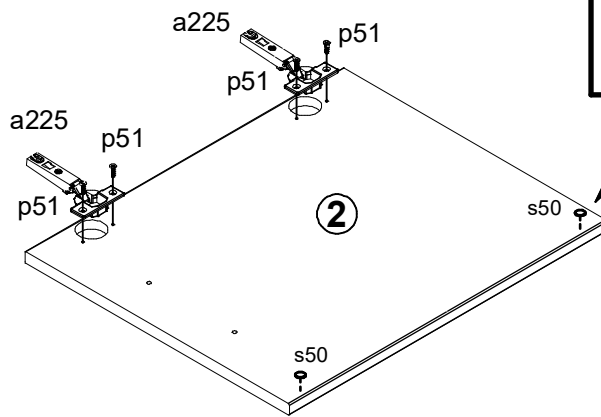
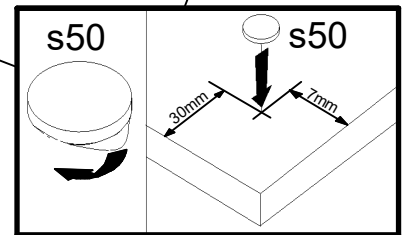
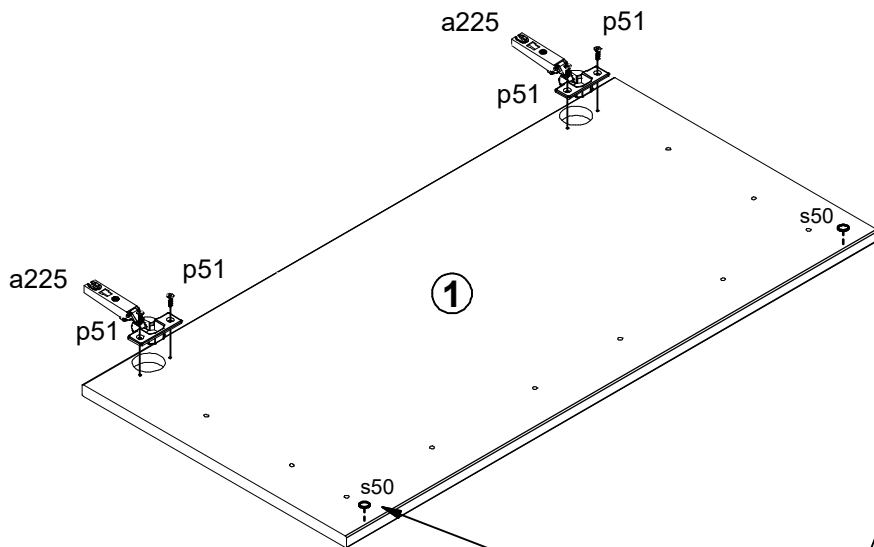
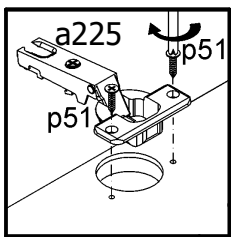
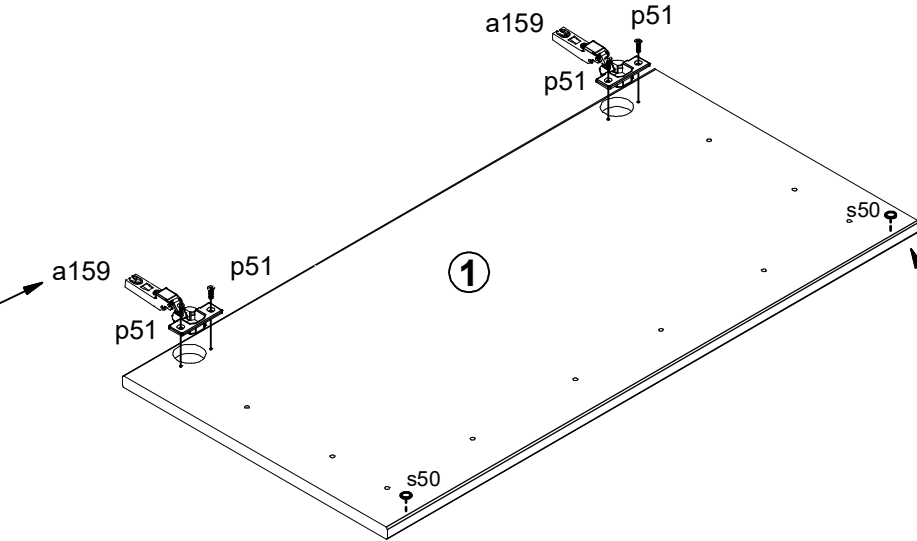
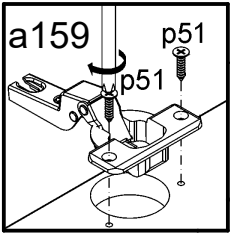



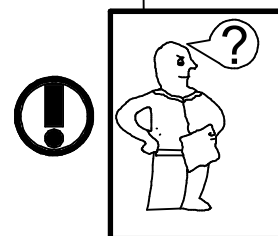
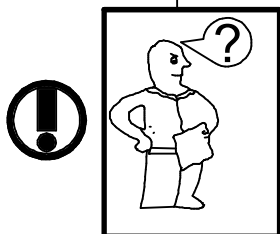
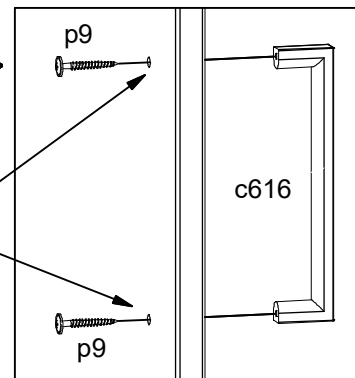
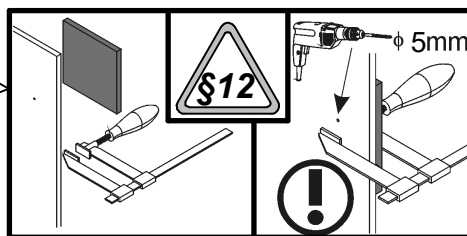
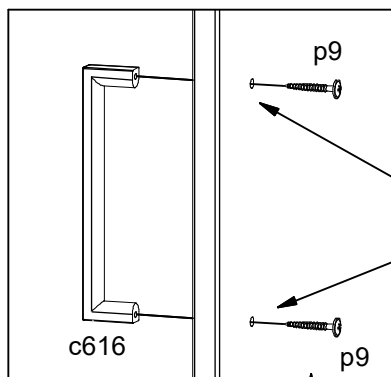
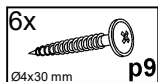
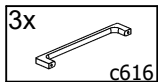

18

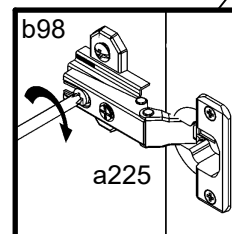
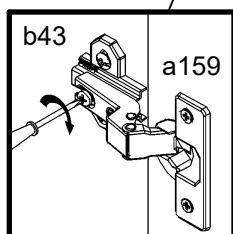
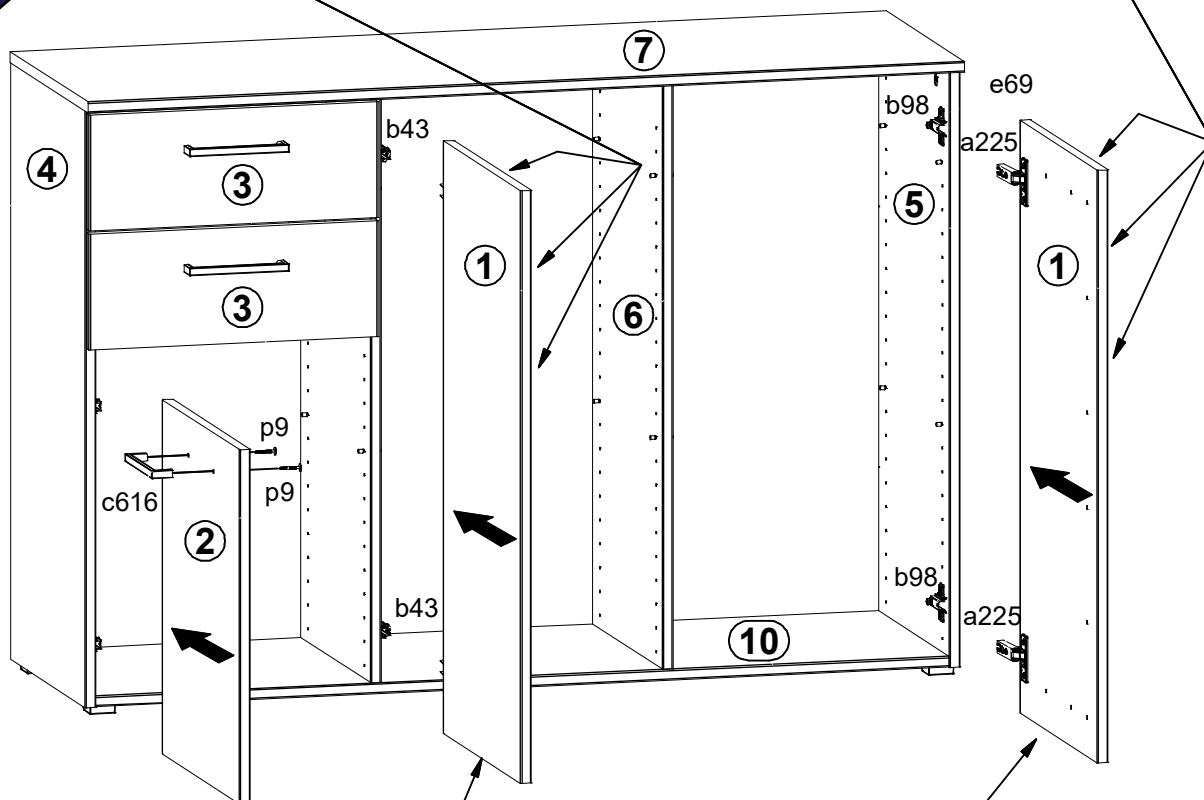



19 ▶

