



(GB) Assembly instructions

(PL) Instrukcja montażu

(DE) Montageanleitung

(CZ) Montážní návod

(FR) Notice de montage

(SK) Návod na montáž

(NL) Handleiding voor de montage

(HR) Montaže

(IT) Istruzioni di montaggio

(TR) Montaj talimat

(HU) Szerelési útmutató

(RO) Instrucțiuni de montaj

(ES) Instrucciones de montaje

(RU) Инструкции по монтажу

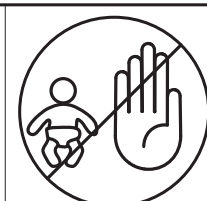
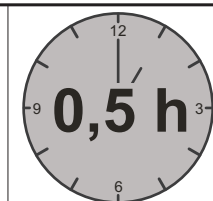
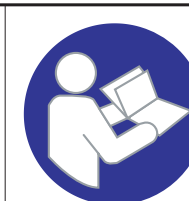
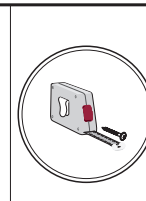
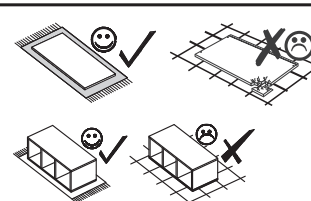
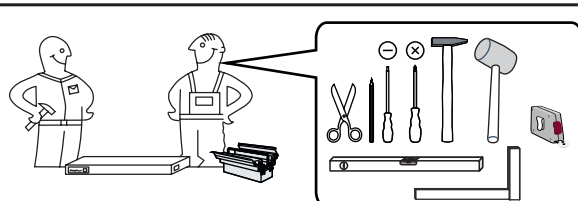
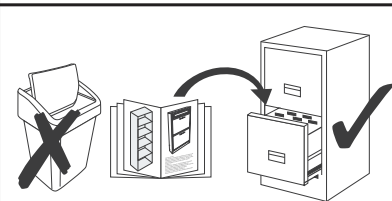
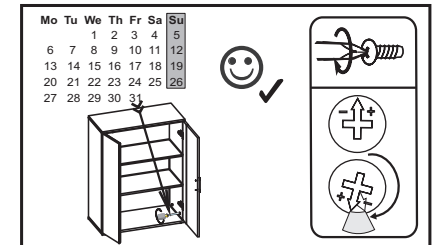
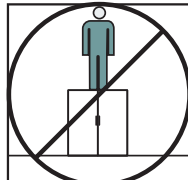
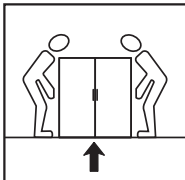
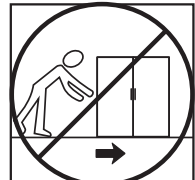
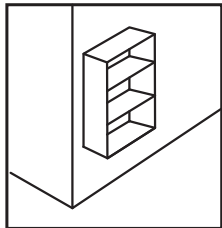
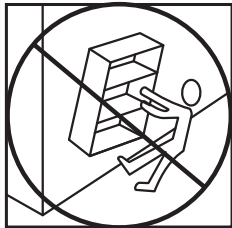

**Service • Assistenza • Dienstverlening • Serwis**  
**Servis • Szerviz • Servizio • Usluga • Нíđâćńír • Нёóćár**

Name • Nom • Nome • Naam • Nazwa  
 Jméno • Názov • Név • Denumire  
 Nombre • Ime • Isim • Írçarıđı

**MONTENEGRO**

shop • geschäft • boutique • sklep • winkel • ёřarıçđı  
 negozio • bolt • tienda • obchod • dućan • mađaza • magazin

Nr. • No. • N° • řířěđ • Ć • Sz • Ne

**SIDR35..**

Typ • Type • Tip • Típus • Tipo • Њćđ

**11**

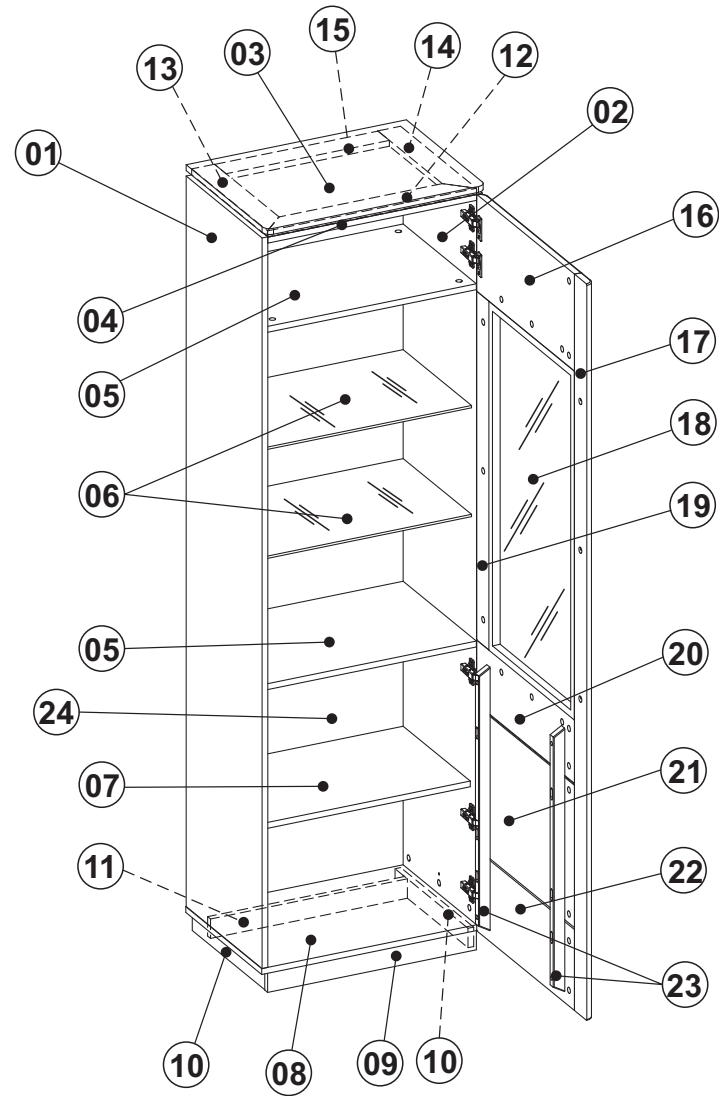
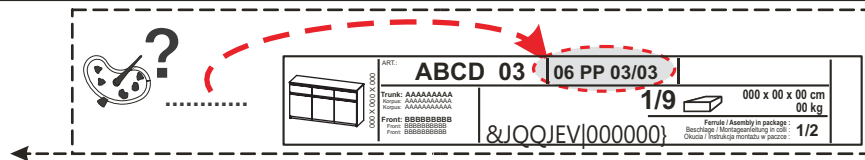
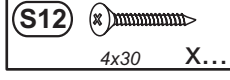
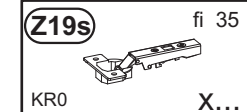
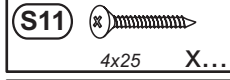
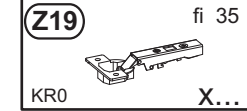
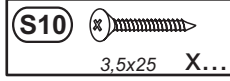
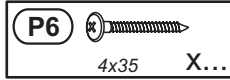
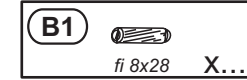
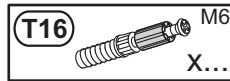
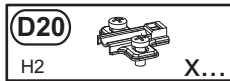
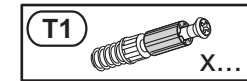
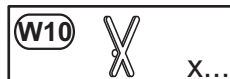
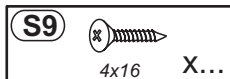
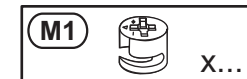
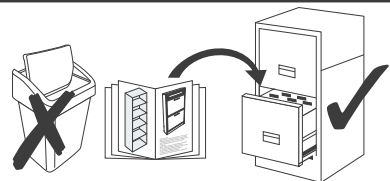
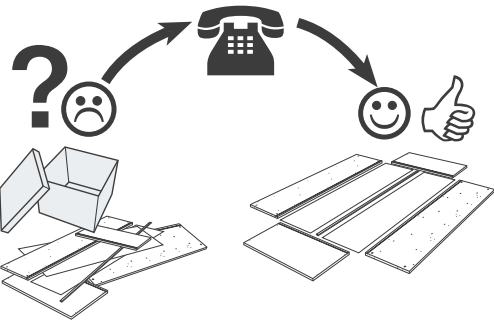







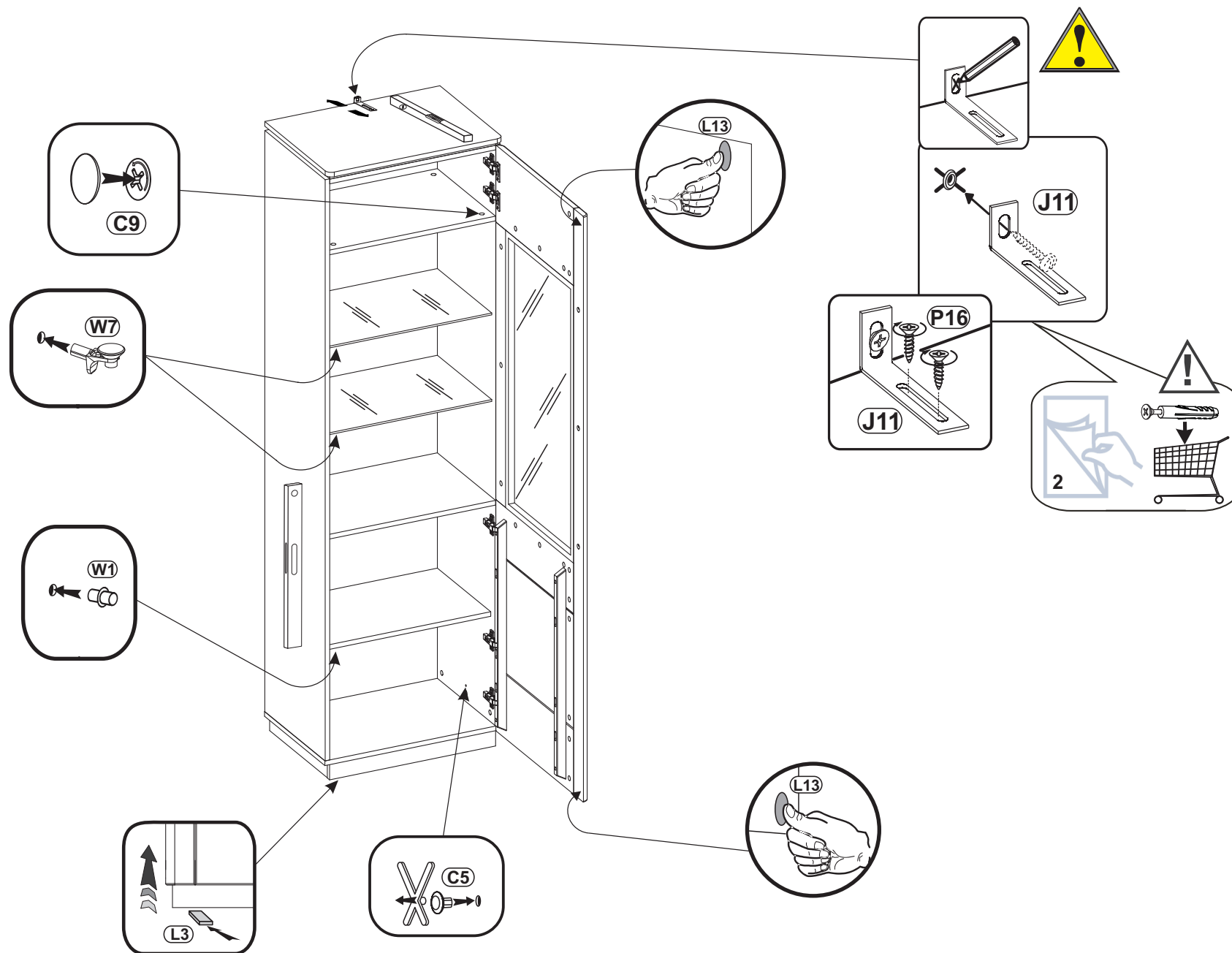

max.  
 6KG **05**

max.  
 4KG **06**  
**07**



1



- W7**  x8
- C5**  fi 5 x2
- W1**  x4
- C9**  fi 20 x12
- L13**  SJ x2
- J11**  x1
- P16**  4x16 x2
- L3**  45x15 x4

1

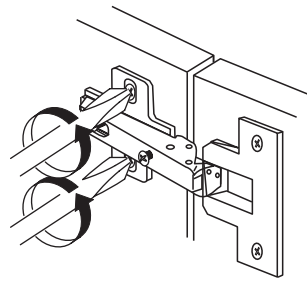
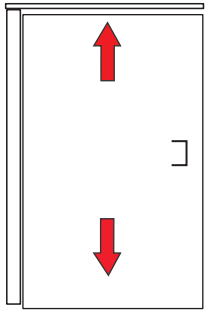

2

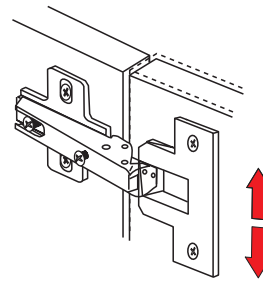

3

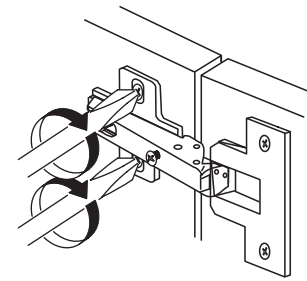

1

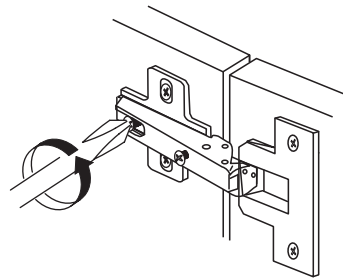
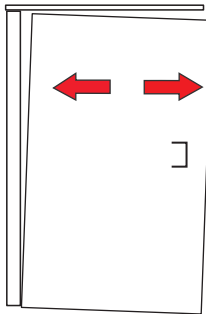

2

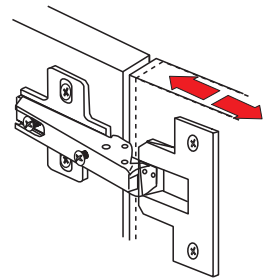

3

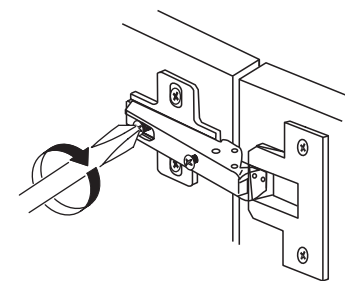

1

