

**A**

# OFFICE SPACE

**S479-REG/80/200**

| A | B         | C    |     | D   |
|---|-----------|------|-----|-----|
| 1 | S479-1005 | 1965 | 369 | 2/2 |
| 2 | S479-1006 | 1965 | 369 | 2/2 |
| 3 | S479-2004 | 800  | 370 | 1/2 |
| 4 | S479-2005 | 800  | 370 | 1/2 |
| 5 | S479-3003 | 762  | 330 | 1/2 |
| 6 | S479-3004 | 762  | 326 | 1/2 |
| 7 | S479-9303 | 1975 | 771 | 2/2 |

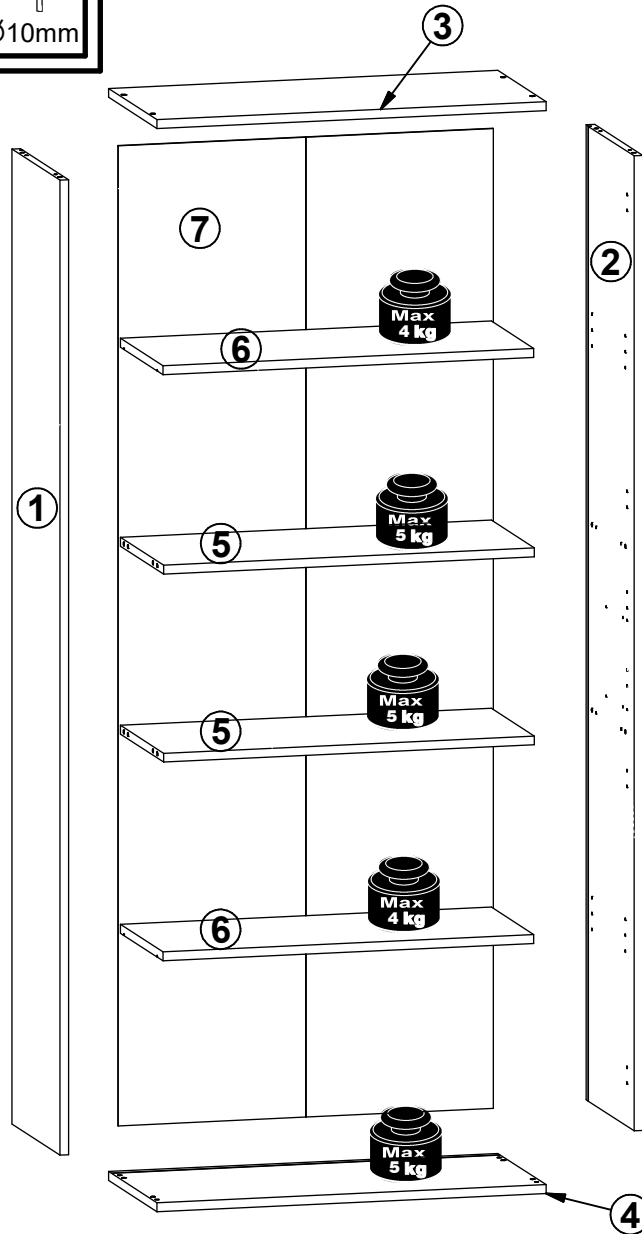
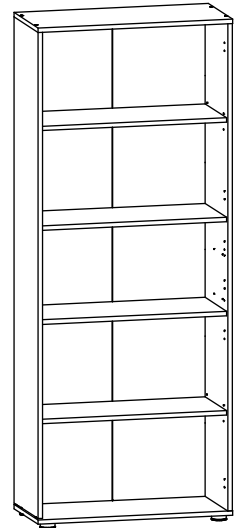
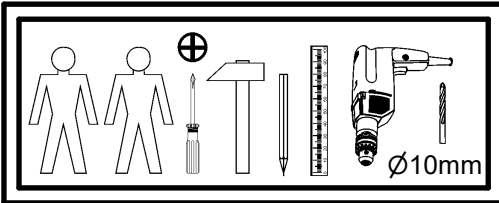

|                             |                             |                               |                              |                                    |                                       |                  |                                |                                  |
|-----------------------------|-----------------------------|-------------------------------|------------------------------|------------------------------------|---------------------------------------|------------------|--------------------------------|----------------------------------|
| 8x<br>Ø5x17 mm<br><b>d1</b> | 8x<br>Ø7x50 mm<br><b>e1</b> | 8x<br>Ø6x13 mm<br><b>e3</b>   | 16x<br>Ø8x30 mm<br><b>f1</b> | 4x<br>Ø51 mm<br><b>k821\1</b>      | 4x<br>Ø58,6x52,18 mm<br><b>k821\4</b> | 14x<br><b>l2</b> | 8x<br>Ø2,9x16 mm<br><b>p55</b> | 8x<br>Ø15x12 mm #16<br><b>r1</b> |
| 8x<br>20/11<br><b>r42</b>   | 1x<br>4 mm<br><b>z1</b>     | 1x<br>Ø10x50 mm<br><b>f35</b> | 1x<br>Ø5x60 mm<br><b>p17</b> | 1x<br>88x21x15/1,5<br><b>n14\2</b> | 2x<br>Ø3,5x16 mm<br><b>p38</b>        |                  |                                |                                  |

1 

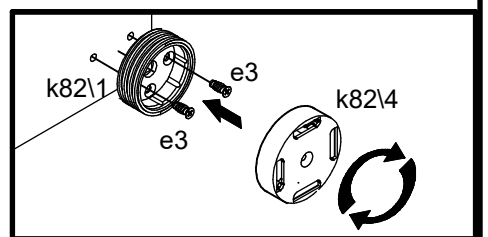
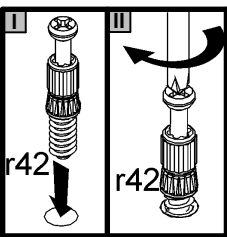
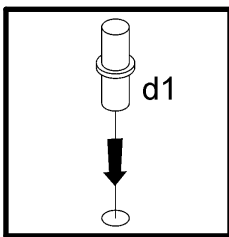
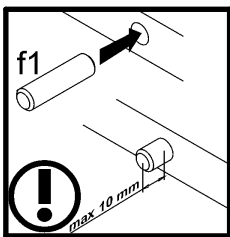
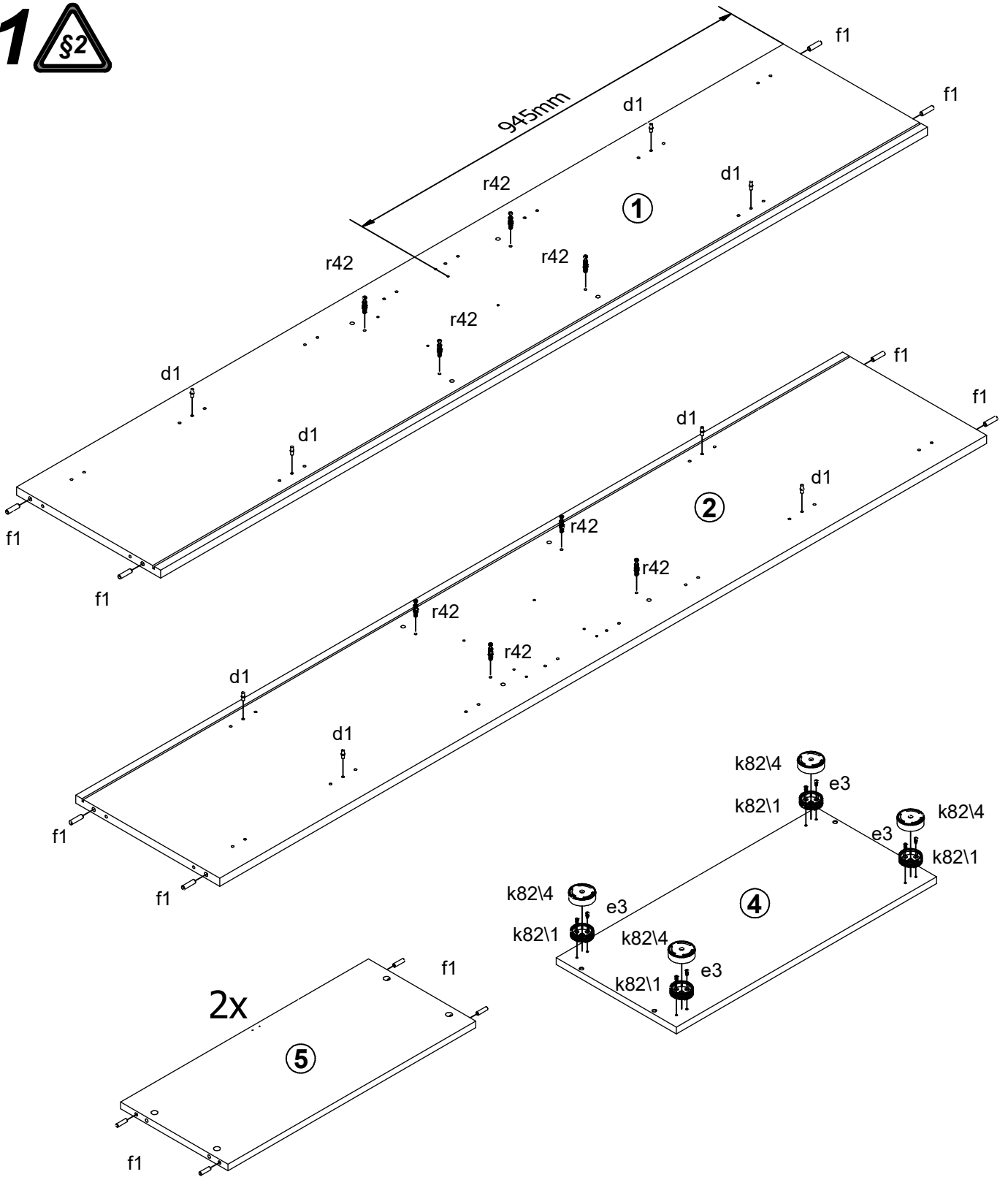

# 2

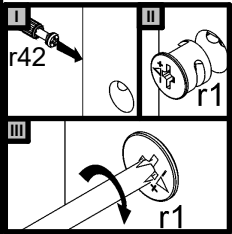
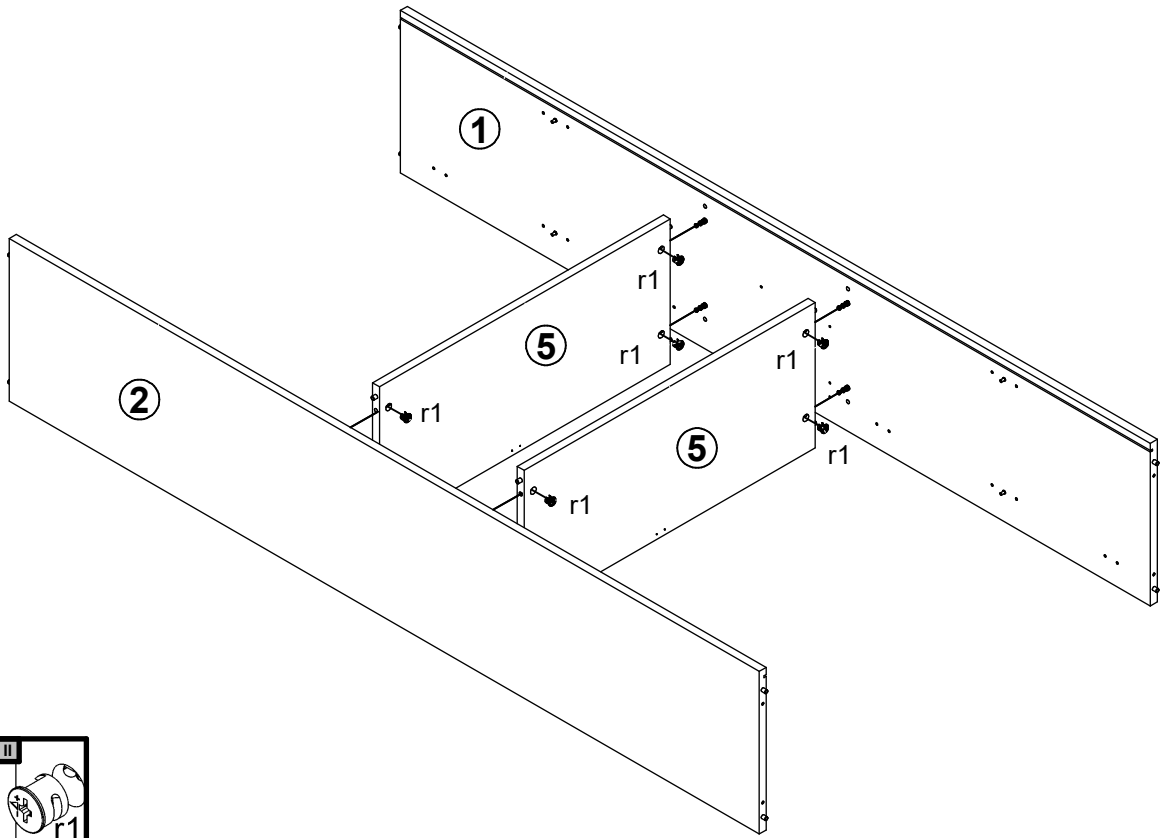

# 3

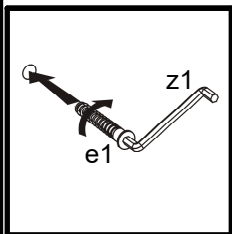
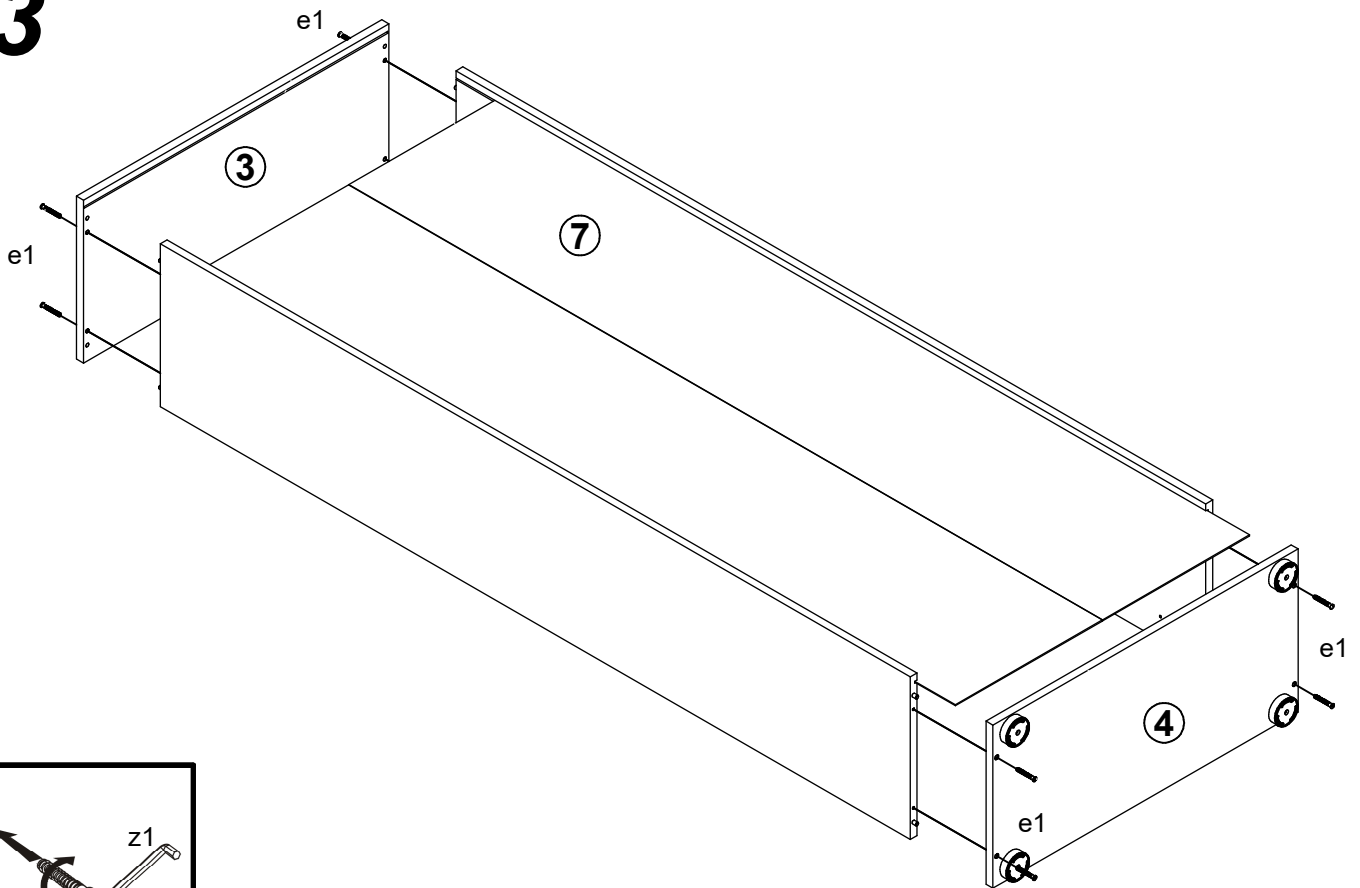



| A | B         | C   | D   |
|---|-----------|-----|-----|
| 1 | S479-0005 | 798 | 377 |
| 2 | S479-0006 | 798 | 377 |

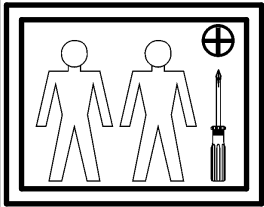
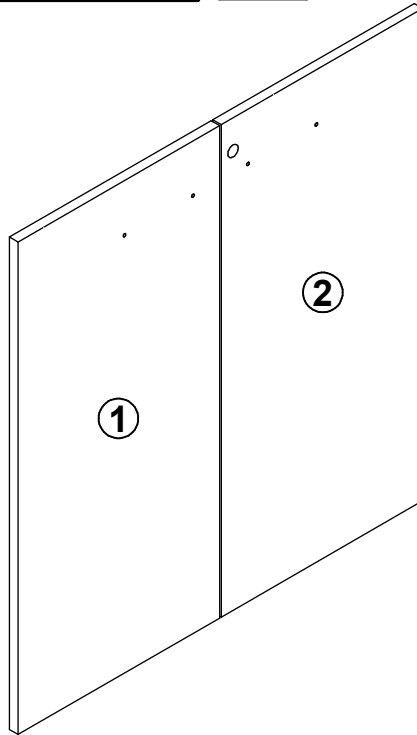

|                       |             |             |                       |                       |                         |                         |                                |                       |
|-----------------------|-------------|-------------|-----------------------|-----------------------|-------------------------|-------------------------|--------------------------------|-----------------------|
| 2x<br>hamulec<br>a203 | 2x<br>a210  | 4x<br>b90   | 2x<br>128mm<br>c280   | 4x<br>M4x22 mm<br>j30 | 8x<br>Ø3.5x15 mm<br>p51 | 4x<br>Ø2.9x16 mm<br>p55 | 1x<br>zamek<br>prawy<br>z39\1P | 1x<br>zaczep<br>z39\3 |
| 1x<br>zaczep<br>z39\4 | 1x<br>z39\2 | 2x<br>z39\5 | 4x<br>Ø3x20 mm<br>p14 | 2x<br>silikon<br>s104 |                         |                         |                                |                       |

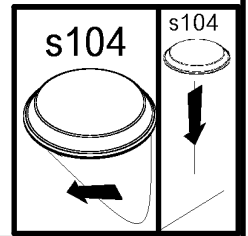
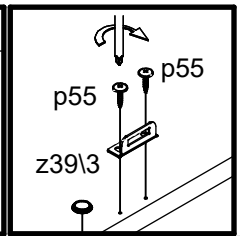
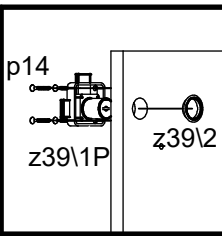
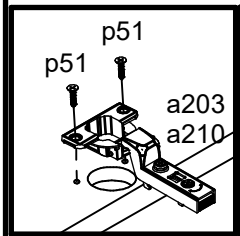
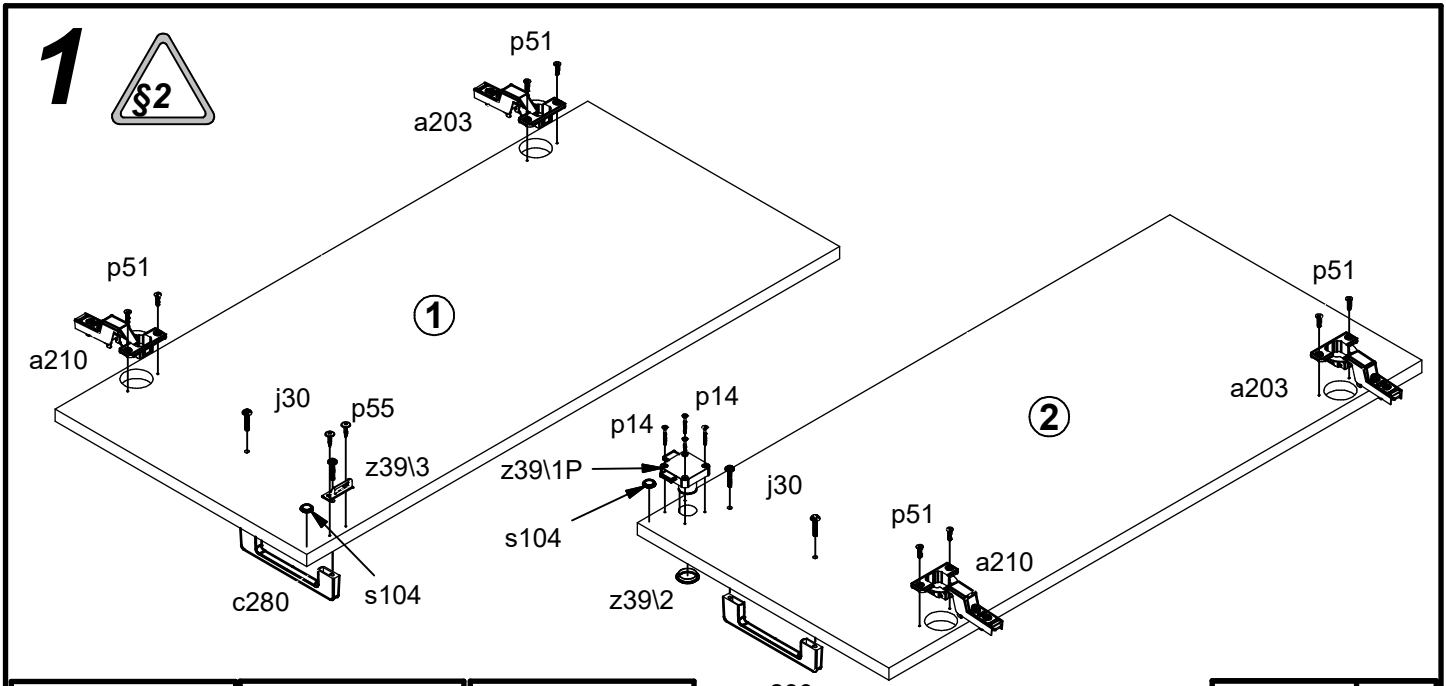

# 2A

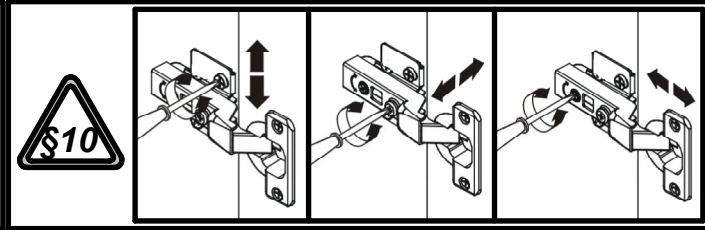
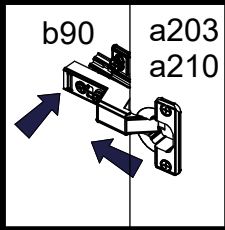
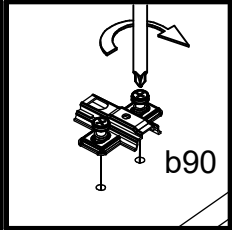
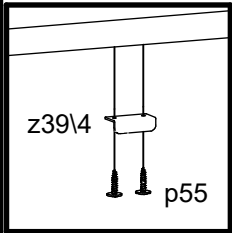
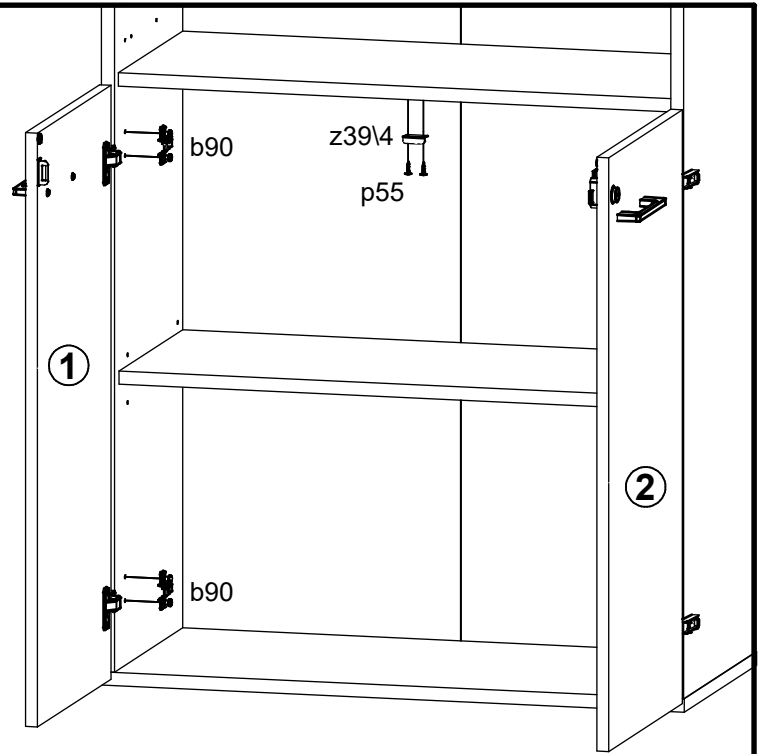
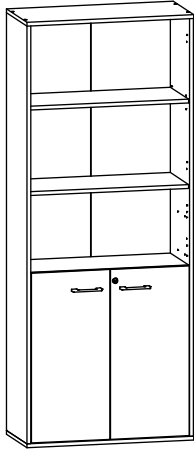

# 2B

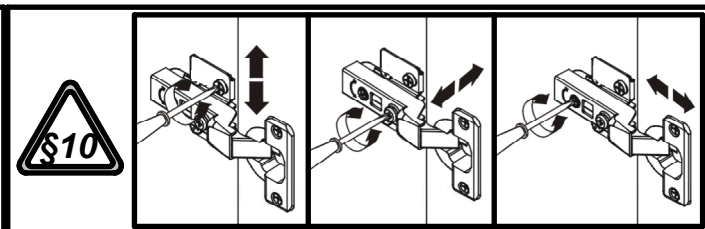
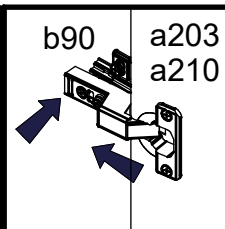
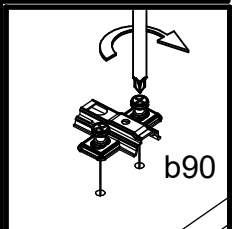
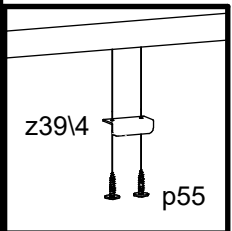
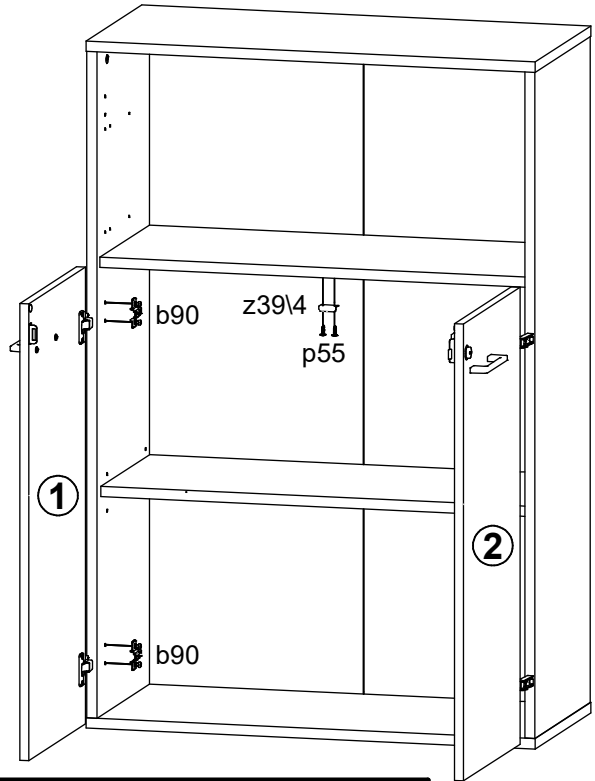
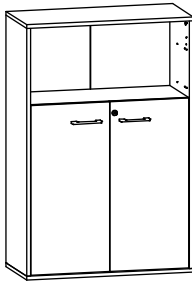

| A                  | B         | C    | D   |
|--------------------|-----------|------|-----|
| 1                  | S479-0004 | 1158 | 377 |
| 2/3, 3/4, 3/6, 5/6 |           |      |     |

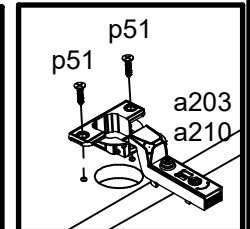
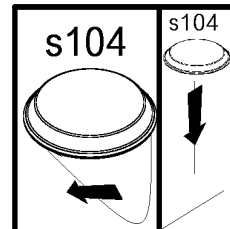
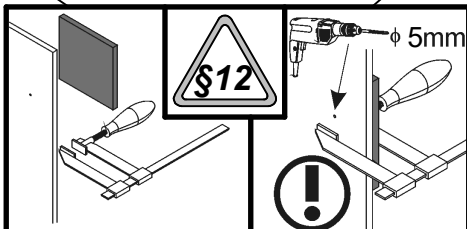
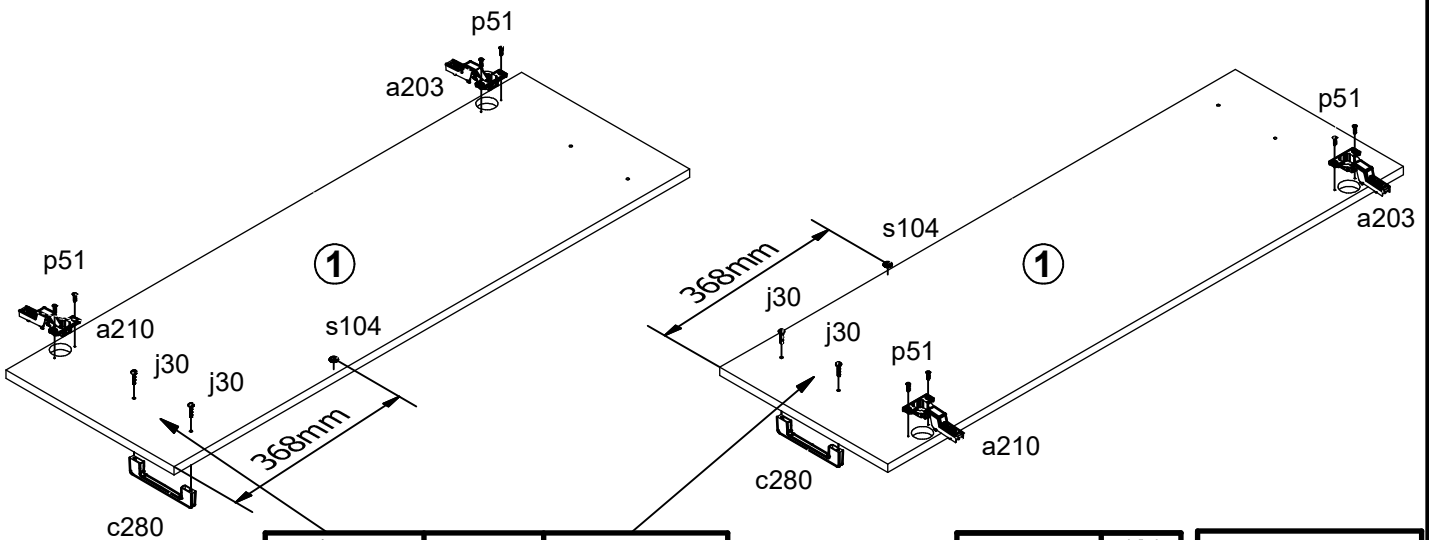
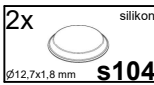
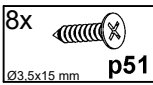
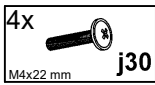
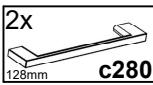
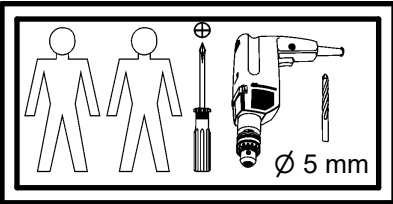
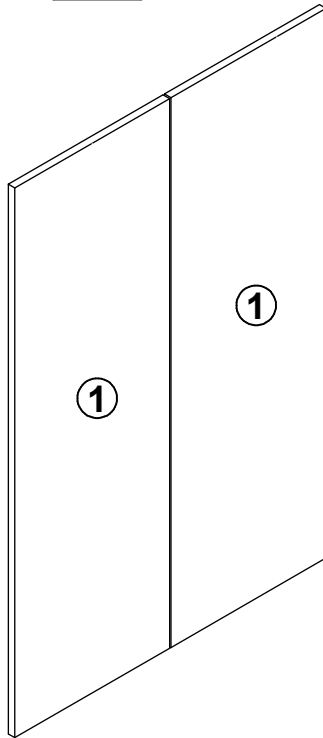

# 2A

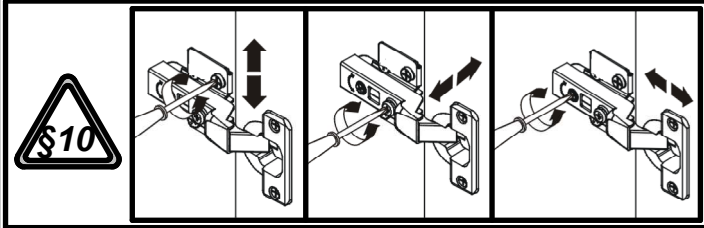
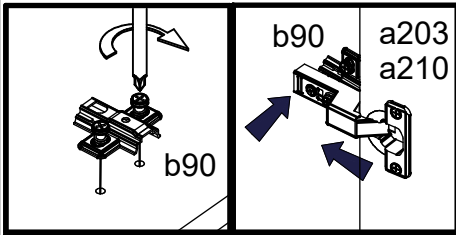
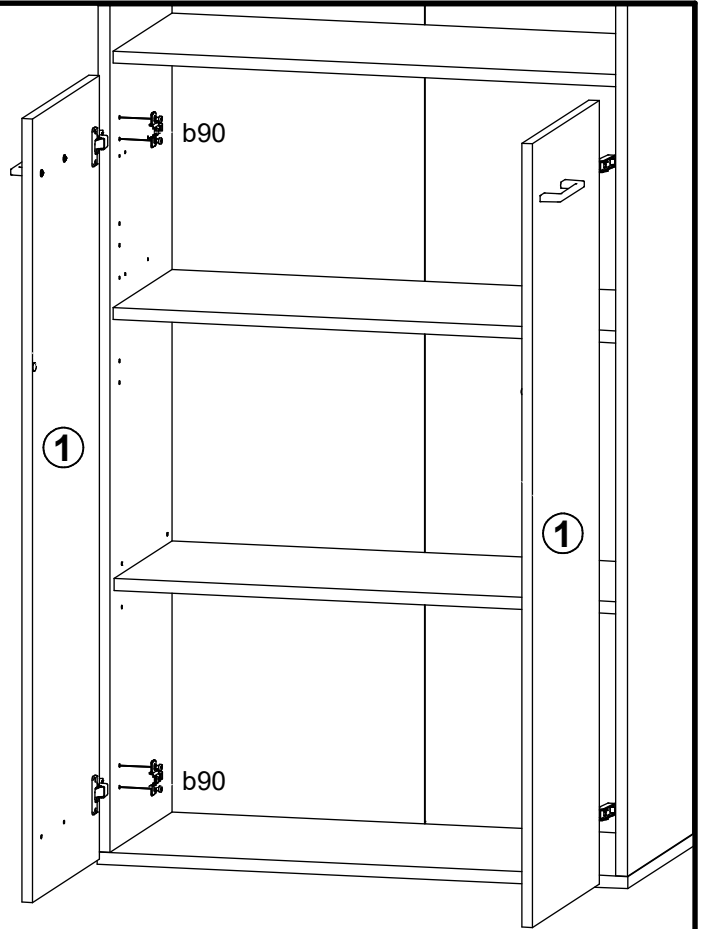
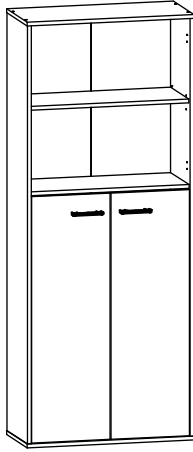

# 2B

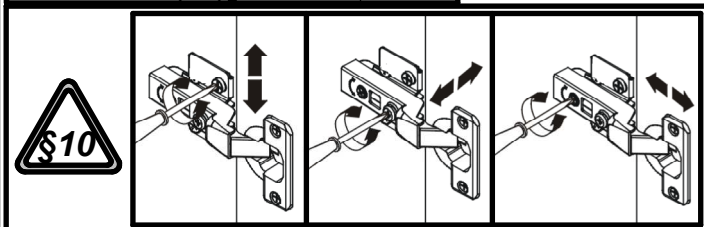
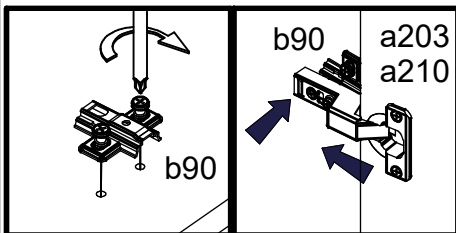
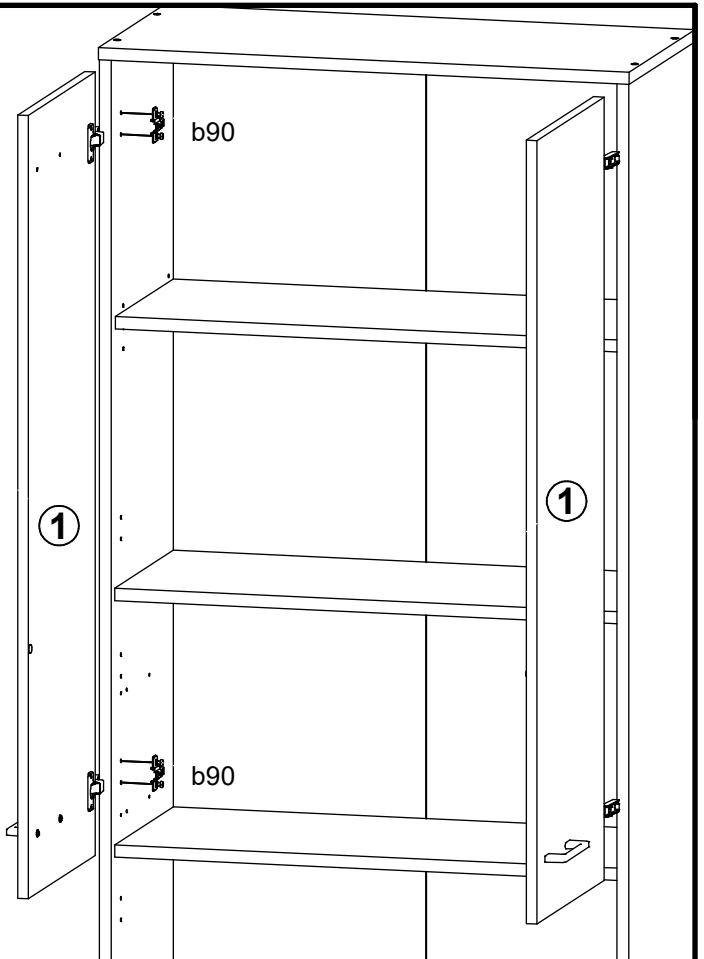
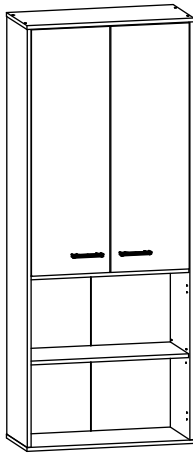



# 2C

